

PO/TBA

2020.5

103.9

(601678 SH) 15.444

" "

2010 2 23 2017

64.65 11.05 15.33

GB/T19001 GB/T24001 GB/T23331 GB/T28001

GB/T22000

1500 m³

6.9 m³

40%

60%

Ca(OH)₂

70%

CaCl₂

HJ2.1-2016

1

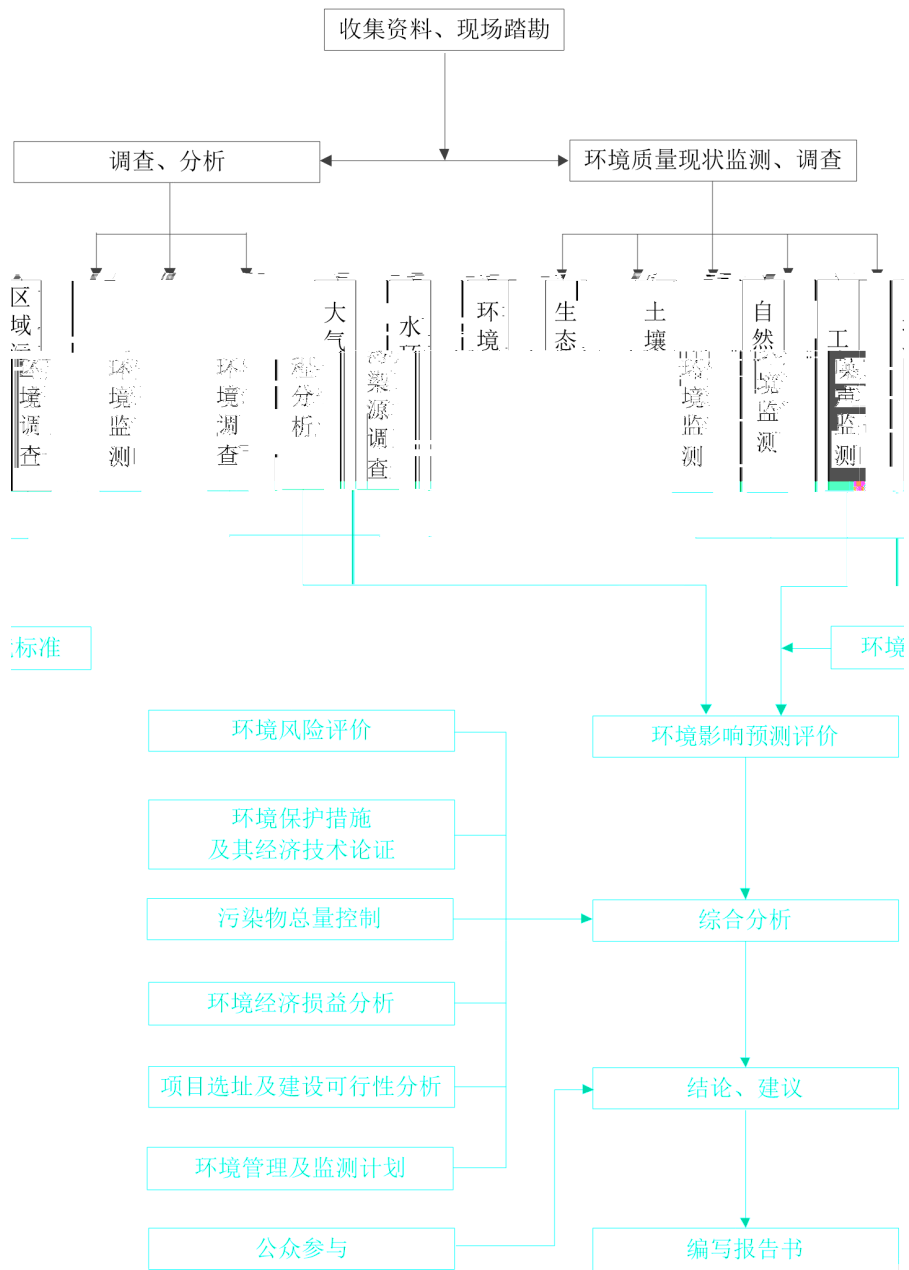

2019

1

1 2017 PM₁₀ PM_{2.5}

GB3095-2012

2

GB3838-2002

2

1

2017

VOC_s

VOC_s

100%

2

4

DB37/3416.4-2018

2

47.25m³/a

72m³/a

119.25m³/a

3

3

1,2-
GB/T14848-2017

7200d

COD

350m

4

GB12348-2008 3

5

1# 2# 3# 4#

GB36600-2018 1

5# 6#

GB15618-2018 1

GB36600- 2018

2020 05

1

1.1

1.1.1

2014.4.24

2018.12.29

2018.10.26

2017.6.27

2020.4.29

2018.12.29

2018.8.31

2012.2.29

2014.8.31

2018.10.26

2007.8.30

1.1.2

559

2009.8.12

591

2011.3.2

2013

12

7

682

2017.6.21

1.1.3

2011 35

2013 37

2015 17

2016 31

2016 65

2016 74
2018 22

2010 33

2016

81

2019

29

2015

10

2015 5

1.1.4

17

31

34

35

39

44

4

VOCs

2013 31

2018 9

<

2018 >

2019 4

<

>

2019 28

2012 77

2012 98

<

>

2013 104
< >

2015 4
< > 2015 162

< >

2015 163

2015 178
< >

2013 103

2013 104

2014

30
< > 2014 34

2014 48

< > 2014 177

2016 1686

2016 150

2017

121

2019 16

2018 11

1.1.5

2018.11.30

2018.11.30

2018.12.1

2018.1.23

2018.1.23

<

>

2018.11.30

<

>

2018.1.23

248

2011.12.27

2018.9.5

2015 58

2017 10

2017 15

2017 29

2019 150

2018-2020

2013-2020

2018-2020

2018 17

2018-2020

2018 166

2018-2020

2018 229

2019 29

2019 150

2019

66

2019 146

1.1.6

<

>

2014 126

5

<

> 5

2016 162

<

2016-2020

>

2016 176

<

>

2017 5

<

>

2019 93

2016 141

2019 112

<

>

2019 132

<

>

2019 134

2019 144

1.1.7

- HJ2.1-2016
- HJ2.2-2018
- HJ2.3-2018
- HJ610-2016
- HJ2.4-2009
- HJ19-2011
- HJ169-2018
- 2017 43
- HJ2000-2010
- HJ2015-2012
- HJ2025-2012
- GB18597-2001
- GB18218-2018
- GB/T50934-2013
- HJ819-2017
- HJ947-2018
- HJ884-2018
- HJ2026-2013
- DB37/T3535-2019

1.2

1.2.1

1.2.2

1.2.3

1.3

1.3.1

PVC

1.3-1

1.3-1

1.3-2

1.3-2

		VOCs
		VOCs
		pH COD SS
		TBHP/TBA
		Leq A

1.3.2

1.3-3

1.3-3

	VOCS	VOCS
	pH CODMn	
	K+ Na+ Ca2+ Mg2+ CO32- HCO3- pH	COD
	1,1- 1,2- 1,2- 1,1 1- 1,1,2-	
	L10 L50 L90 Leq	Leq A
	pH	
	-1,2- 1,1- 1,2- 1,1-	
	2- 1 1 2 2- 1,2- 1 1 1-	1 1 1
	1 2- 1 2 3-	1
	2- 1 4- +	
	[k] 2- [a] [a] [b]	
	[a,h] [1 2 3-cd]	
		--

1.4

1.4.1

HJ2.2-2018

VOC_s =76.05% 10%

1.4.2

90%

47.25m³/a

72m³/a

119.25m³/a

HJ2.3-2018 5.2 "

B"

B

1.4.3

1.4-1

1.4-1

1.4.4

3dB(A)

HJ2.4-2009

1.4.5

1.4-2

1.4-2

--	--	--	--

	" " "		
	" " "		
	458.4m ²		

1.4.5

Q 1

HJ169-2018

1.4-2

1.4-2

	VOCs =76.05% 10%	
		B
	3dB(A)	

1.5

1.5.1

1.5-1

1.5-1

1	118.058520°E 37.379958°N	5km
2		500m 3000m
3	≤6km ²	
4	200m	
5	200m	

1.5.2

1.5-2

1.5-1

1.5-2

				m	
	1		SW	490	2187
	2		SW	1380	823
	3		SW	1170	325
	4		SW	1340	600
	5		SW	1540	420
	6		W	1350	1017
	7		W	1950	286
	8		W	2060	800
	9		W	1960	400
	10		SW	1760	324
	11		SW	2260	460
	12		NE	2450	280
	13		NE	2720	420
	14		SW	2160	1000
	15		SW	2010	350
	16		SW	1830	350
	17		SW	1240	8000
	18		NW	2740	460
	19		NW	2350	358
	20		N	1500	803
	21		NW	2150	256
	22		N	1990	1310
	23		N	2000	800
	24		NE	2100	880
	25		NW	2300	450
	26		SW	1640	636
	27		SW	1810	621
	28		S	1620	291
	29		S	1080	595
	30		SE	1150	1000
	31		SE	1170	328
	32		SE	1460	144

1.6-2

1.6-2

	pH	COD _{Mn}	NH ₃ -N		
	6-9	≤15mg/L	≤2.0mg/L	≤2.0mg/L	≤0.2mg/L
	≤100mg/L	≤1.0mg/L	≤1.0mg/L	≤1.5mg/L	≤250mg/L
	≤250mg/L	≤1000mg/L	≤40000 /L		

3

GB/T14848-2017

1.6-3

1.6-3

	pH				
	6.5-8.5	≤3.0mg/L	≤0.5mg/L	≤450mg/L	≤1000mg/L
	≤250mg/L	≤250mg/L	≤0.002mg/L		
	3.0CFU/100mL				
	≤20mg/L	≤1.0mg/L	≤1.0mg/L		

4

GB3096-2008 3

1.6-4

1.6-4

3	65dB(A)	55dB(A)

5

GB36600-2018 1

1.6-5

1.6-5

mg/kg	60	65	5.7	18000	800	38
					1,1-	1,2-
mg/kg	900	2.8	0.9	37	9	5
	1,1-	-1,2-	-1,2-		1,2-	1,1,1,2-
mg/kg	66	596	54	616	5	10
	1,1,2,2-		1,1,1-	1,1,2-		1,2,3-
mg/kg	6.8	53	840	2.8	2.8	0.5
				1,2-	1,4-	
mg/kg	0.43	4	270	560	20	28
			+			
mg/kg	1290	1200	570	640	76	260
	2-	[a]	[a]	[b]	[k]	
mg/kg	2256	15	1.5	15	151	1293
	[a,h]	[1,2,3-cd]				
mg/kg	1.5	15	70	45000		

GB15618-2018 1

1.6-6

1.6-6

	mg/kg	
	pH 7.5	
1	0.6	
2	3.4	
3	25	
4	170	
5	250	
6	100	
7	190	
8	300	

1.6.2

1.6.2.1

VOCs				6	
DB37/2801.6-2018	1			VOCs	
VOCs				6	
DB37/2801.6-2018	3				
		6		DB37/2801.6-2018	2
			1.6-7		

3	65	55
---	----	----

1.6.2.4

GB18599-2001

GB18597-2001

2.1

2007 3

15

18

()

1968

1970

9

82.46

2300

PO/PG

GB/T 19001
2010

GB/T 24001

GB/T 28001
254.62

54.84

27.13

2.2

2.2.1

25 /

20 /

12

/ VCM

HCL

15 /

6 /

3 /

8 /

2 /

8 /

2 /

2000 /

2.2.2

2.2-3

2.2-3

25 / 32% 25 t/a 100%
0000t/a 100% 0000t/a 100%

3 t/a

1

PO 6 t/a

2 t/a

2.0 /

2000 / 2000 /

2

2

			200t/h 0.89MPa 200 0.8MPa 129.18t/h
		2	2 1000m ³ / P-1001ABC 3 750m ³ /h P-1001D 1 288m ³ /h P-2001AB 2 1000m ³ /h 4000m ³ /h
			3
		2000Nm ³ /h	5000Nm ³ /h DN250
		4435Nm ³ /min	892Nm ³ /h
4			
			PO
		PVC	
			5400m ³

2.2.3

560778.319m²

3

1

1

1

PVC

2.2-1

2.2.4

2.2-4

2.2-4

		t/a	
1	32%	247225	
2	50%	40000	
3		5809	
4	31%	20760	
5	75%	2402	
6		29851	
7		5585	
8		5908	
9		7700	
10		100000	
11		100000	
12		942500	
13		60000	
14		10000	
15	35%	5800	
16	35% 27.5%	10000	
17		20000	
18	POP	80000	
19		20000	
20		2000	

2.2.5

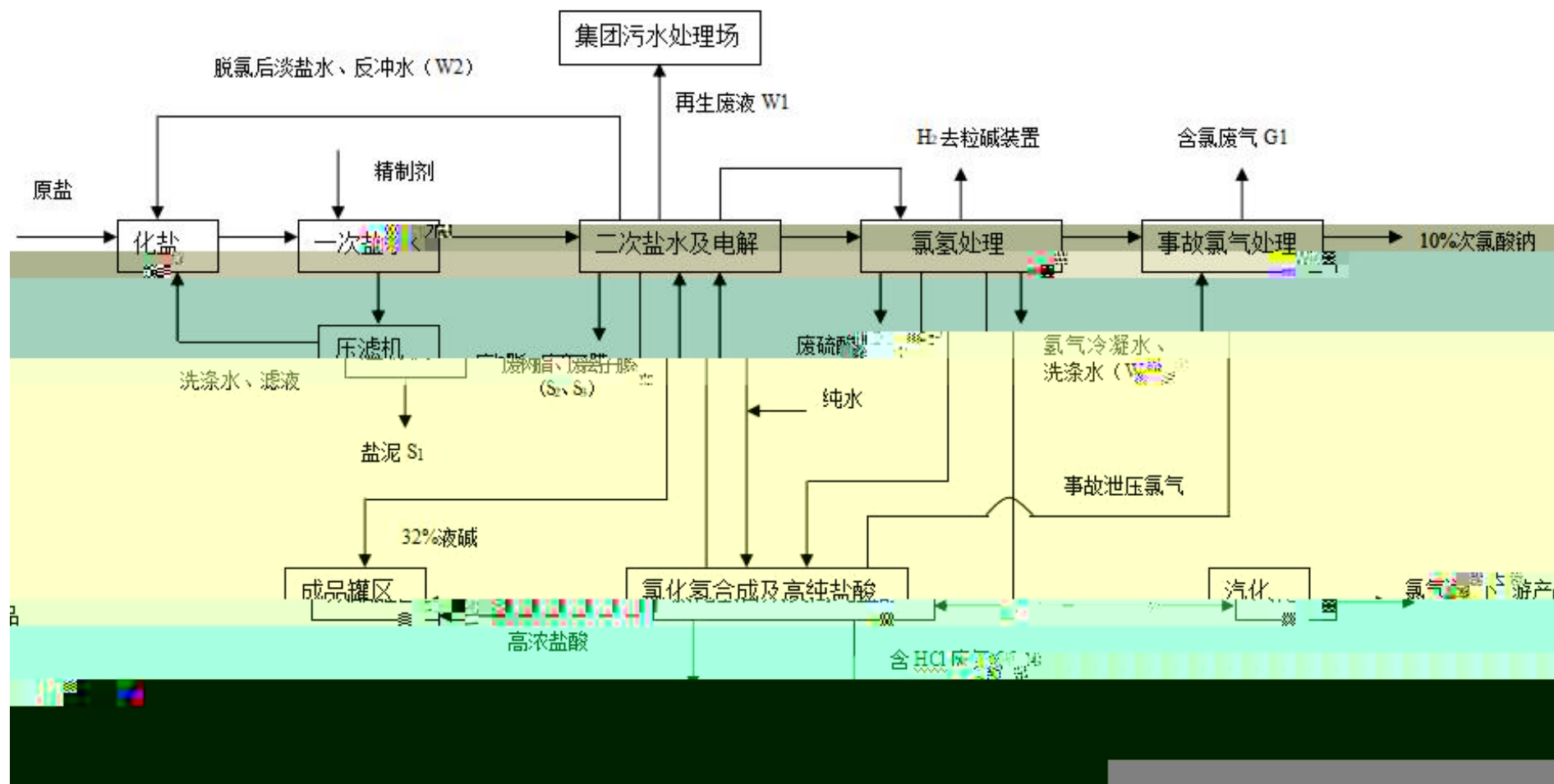

2

32%

50%

2.2-2

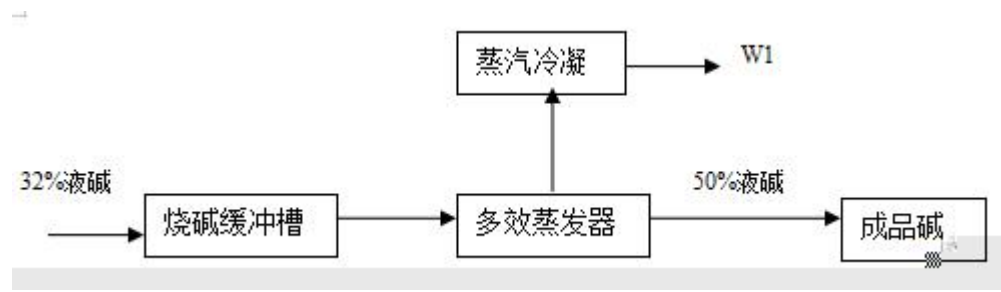

3

50%

50%

97.5

97.8%

62%

97.8%

2.2-3

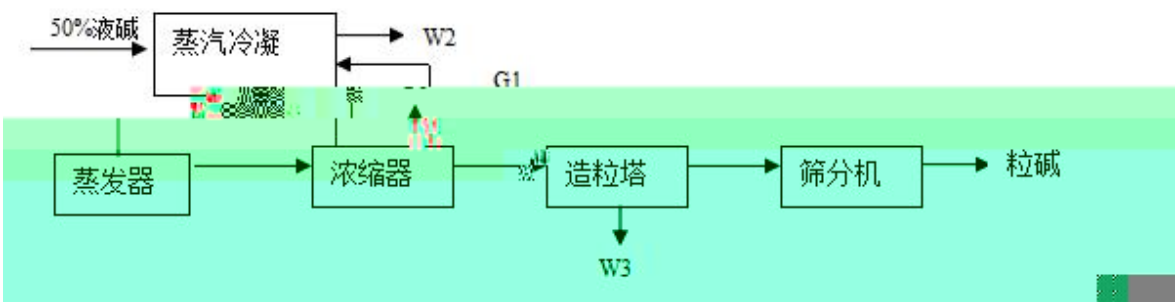

4

2.2-4

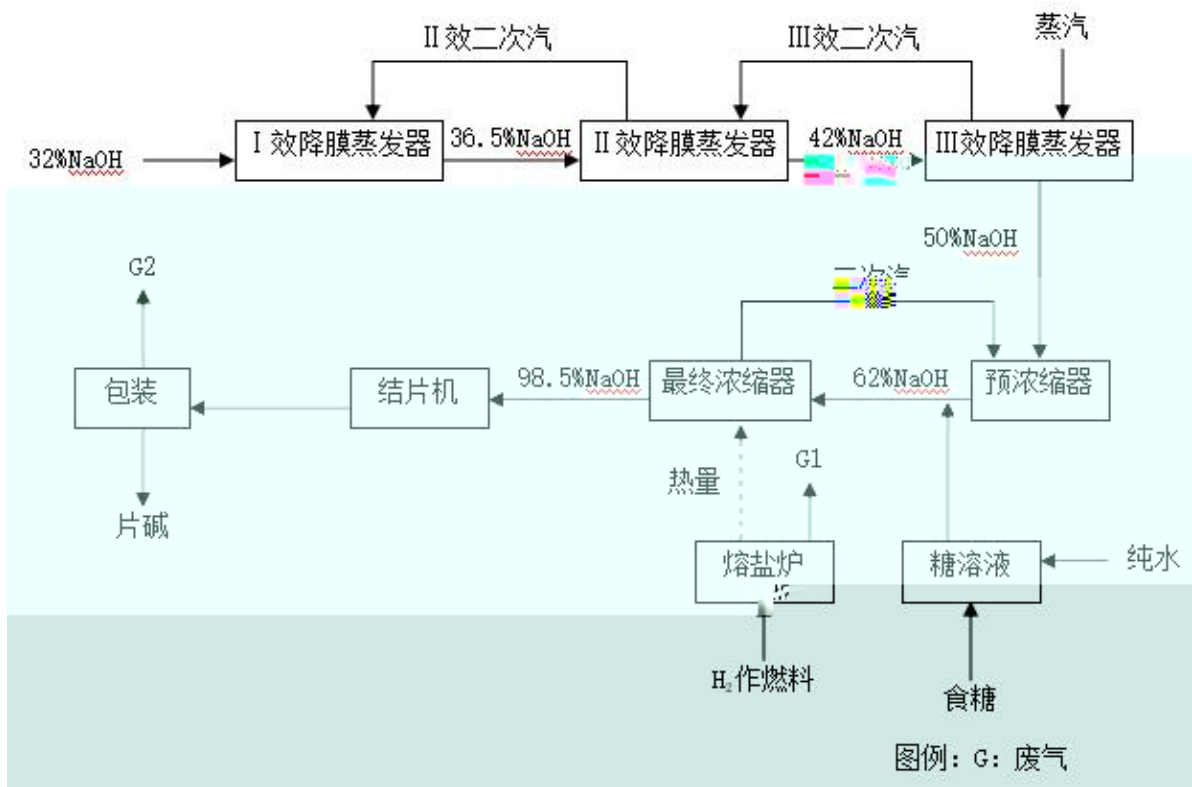

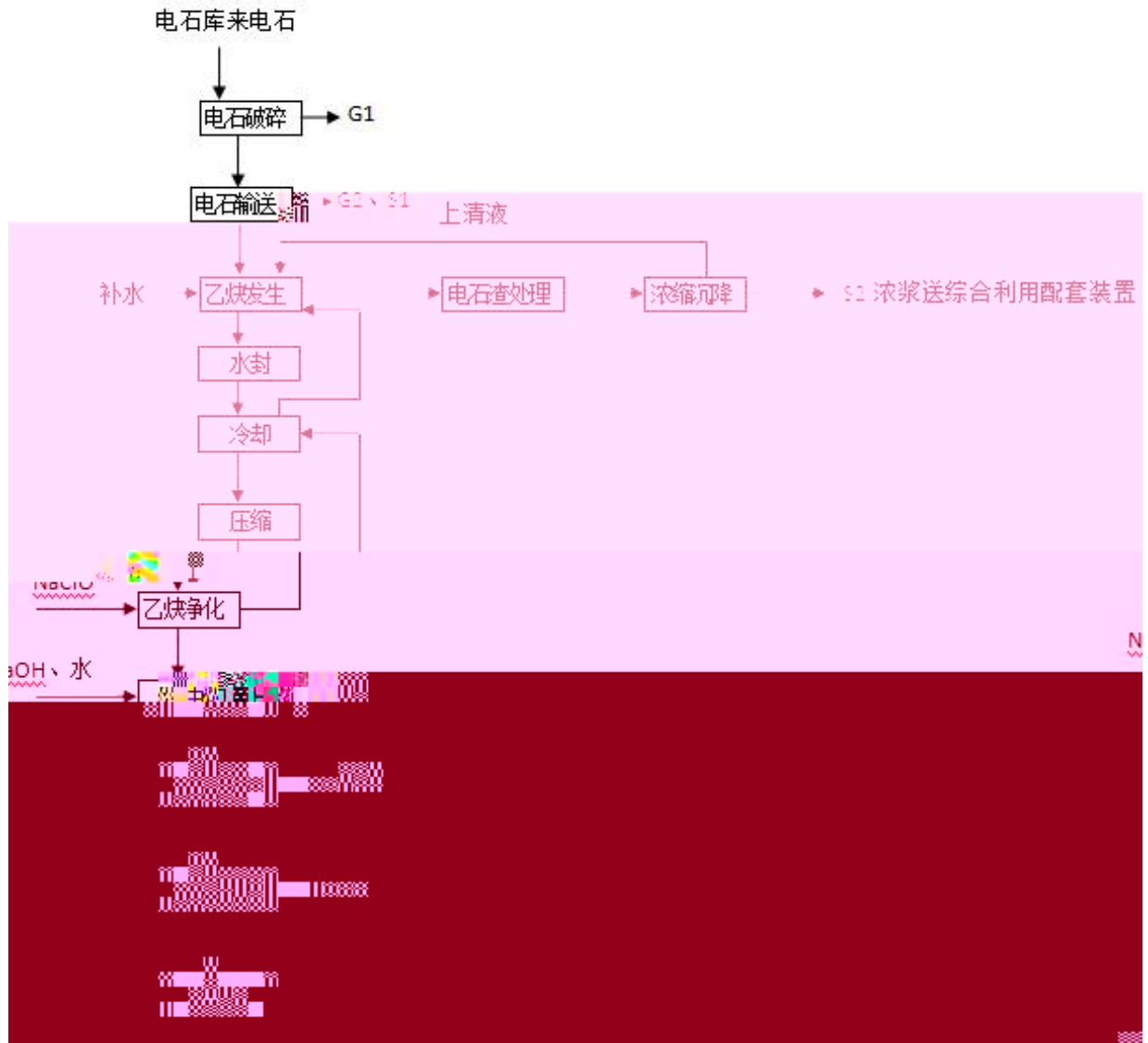

Ca(OH)₂

2.2-6

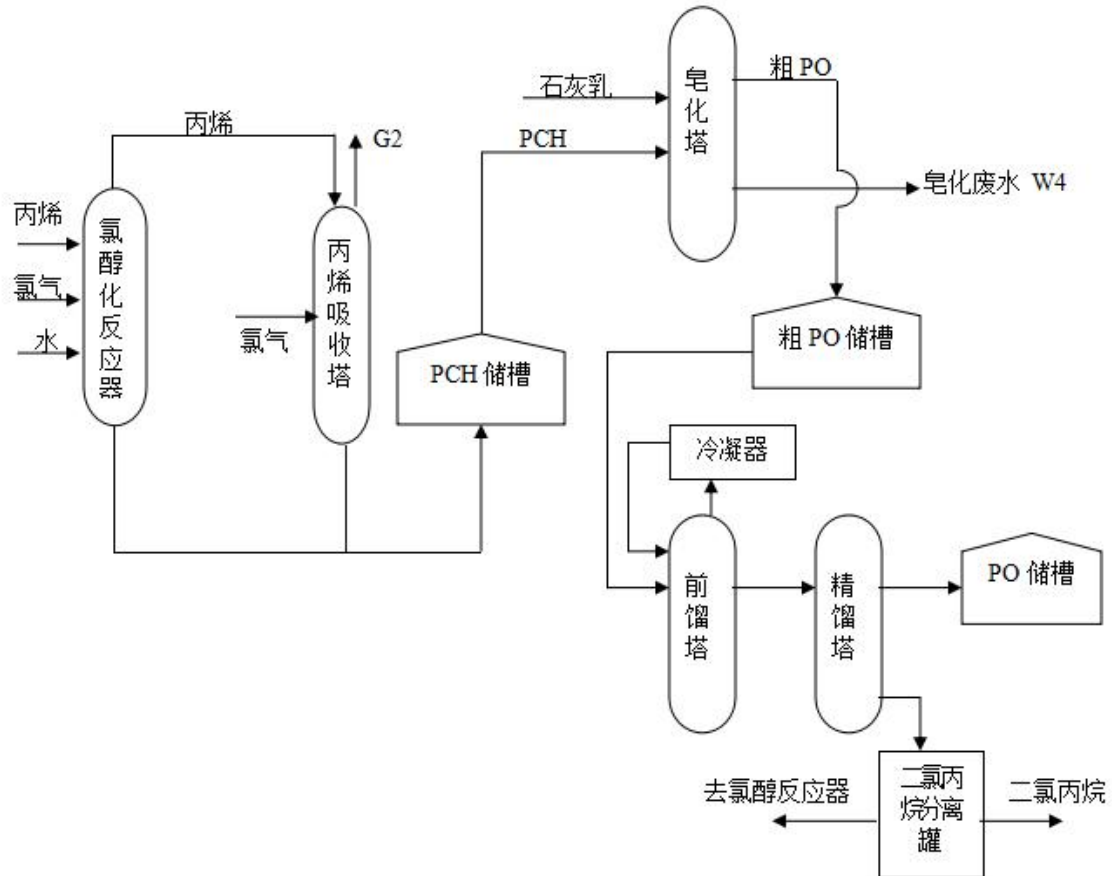

2.2-7

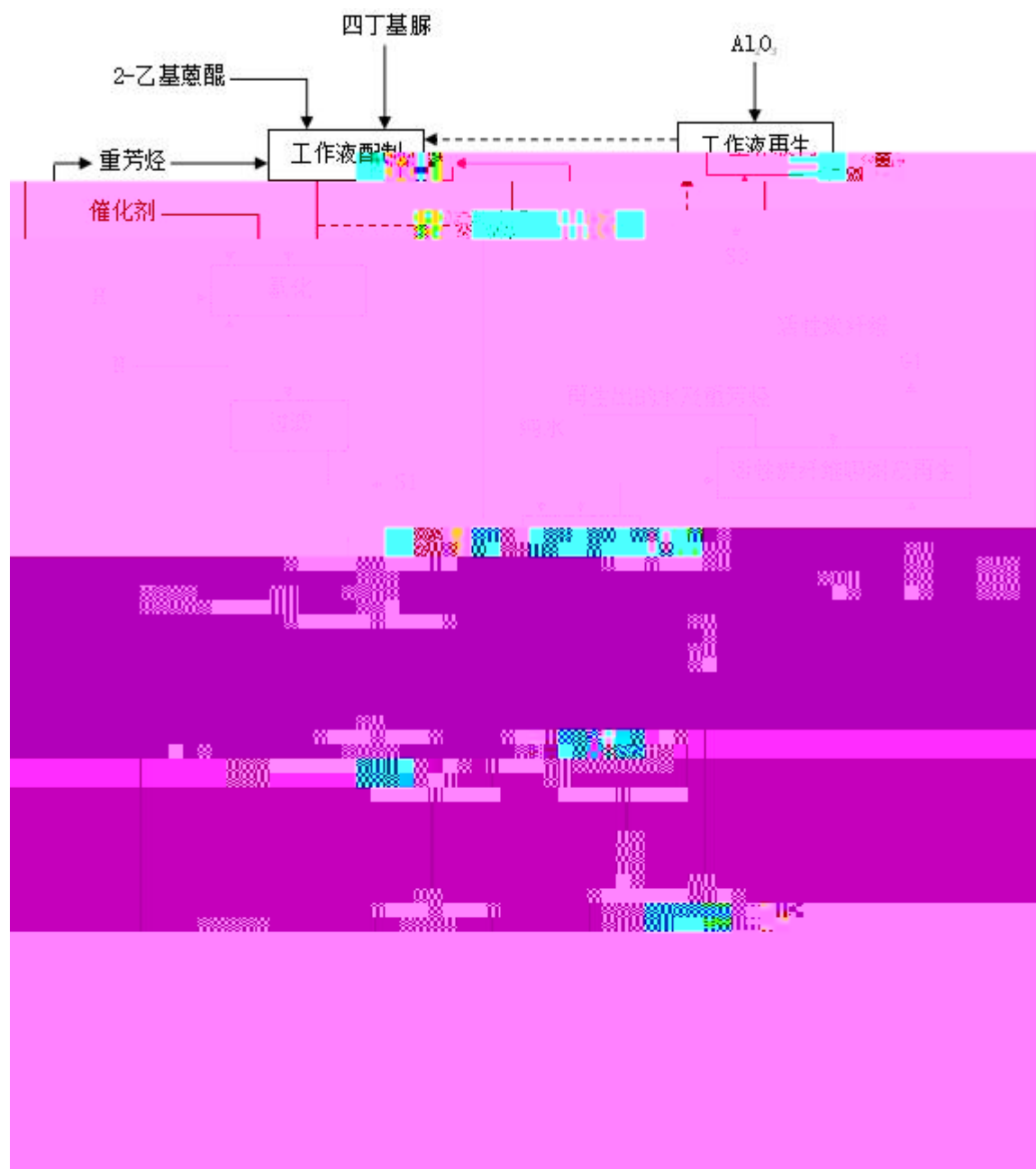

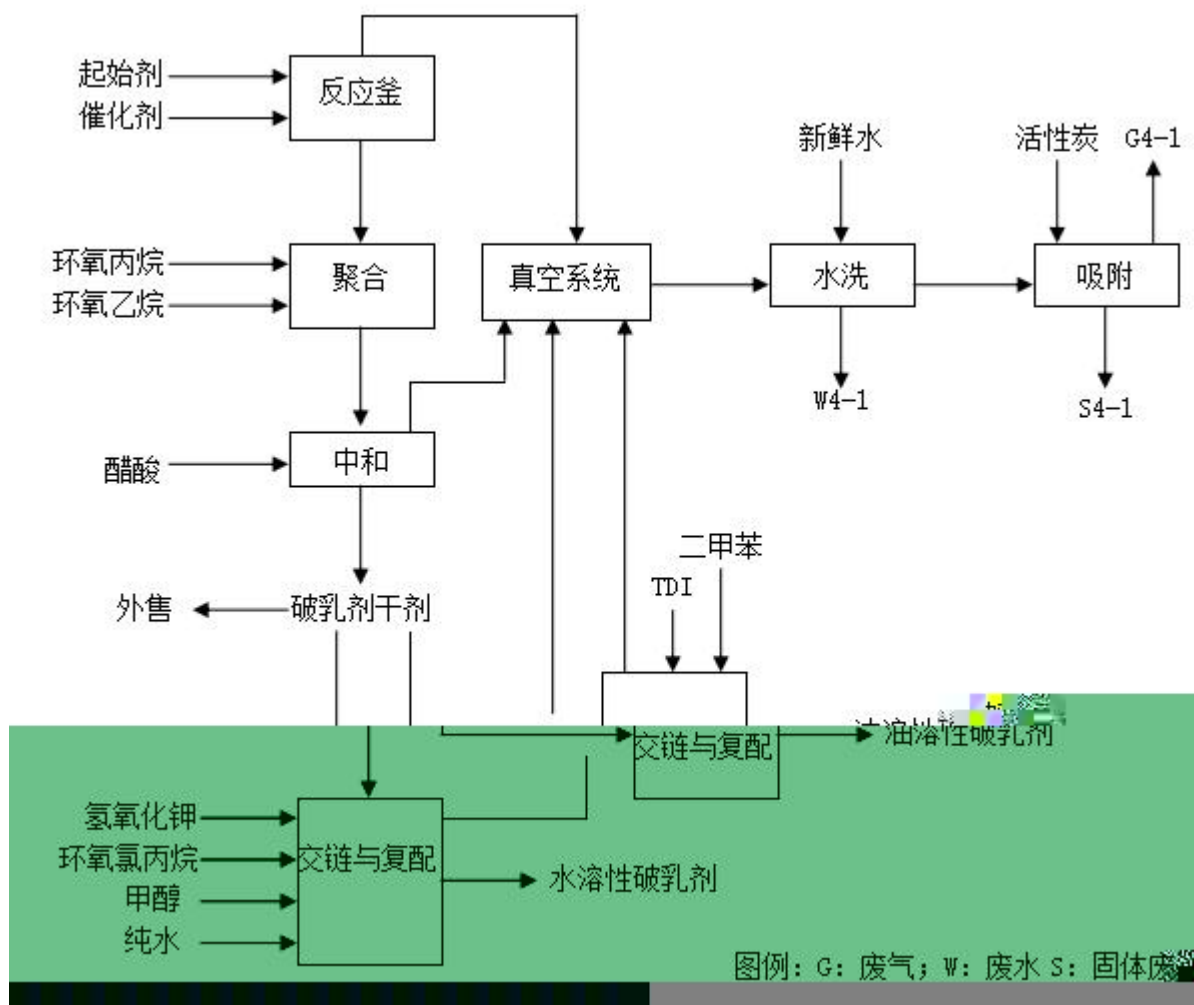

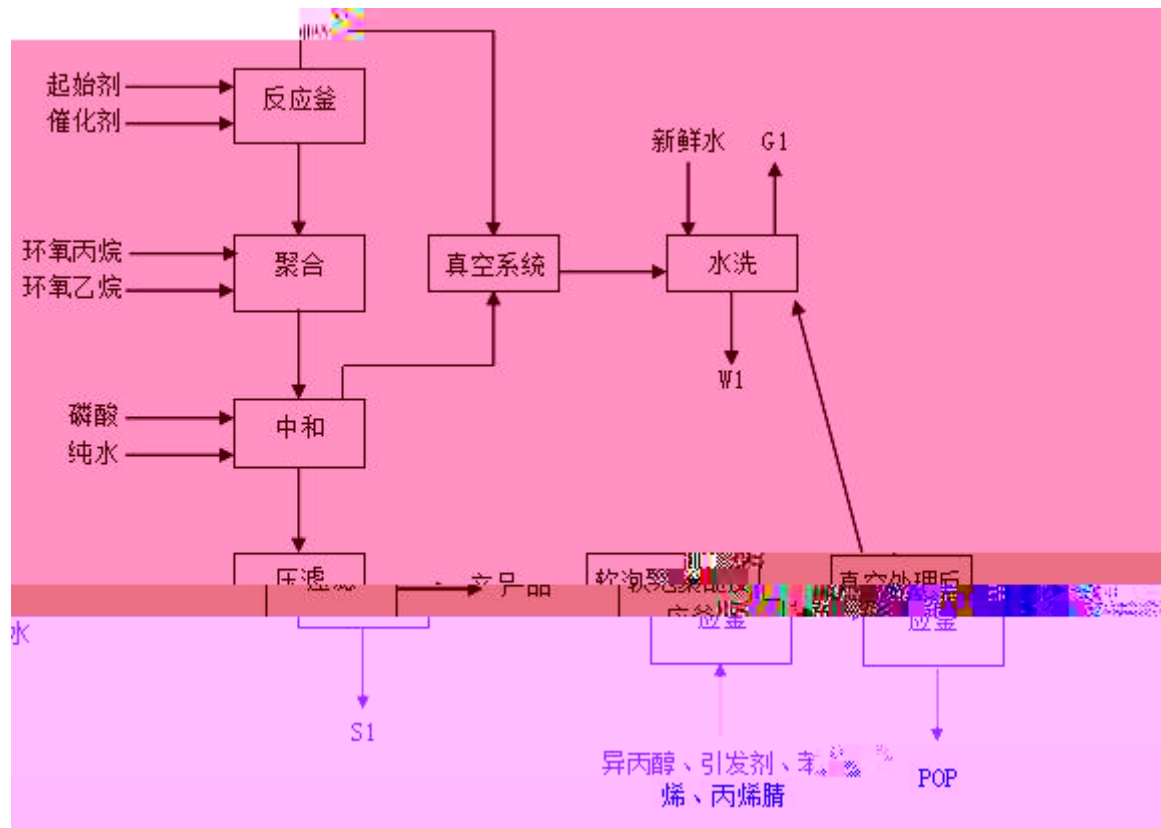

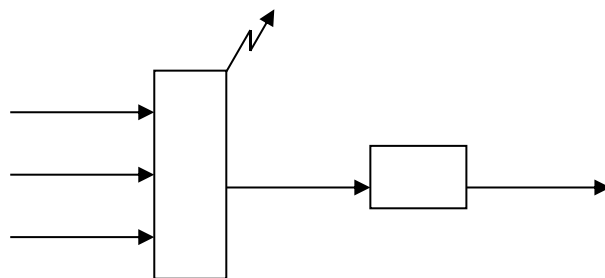
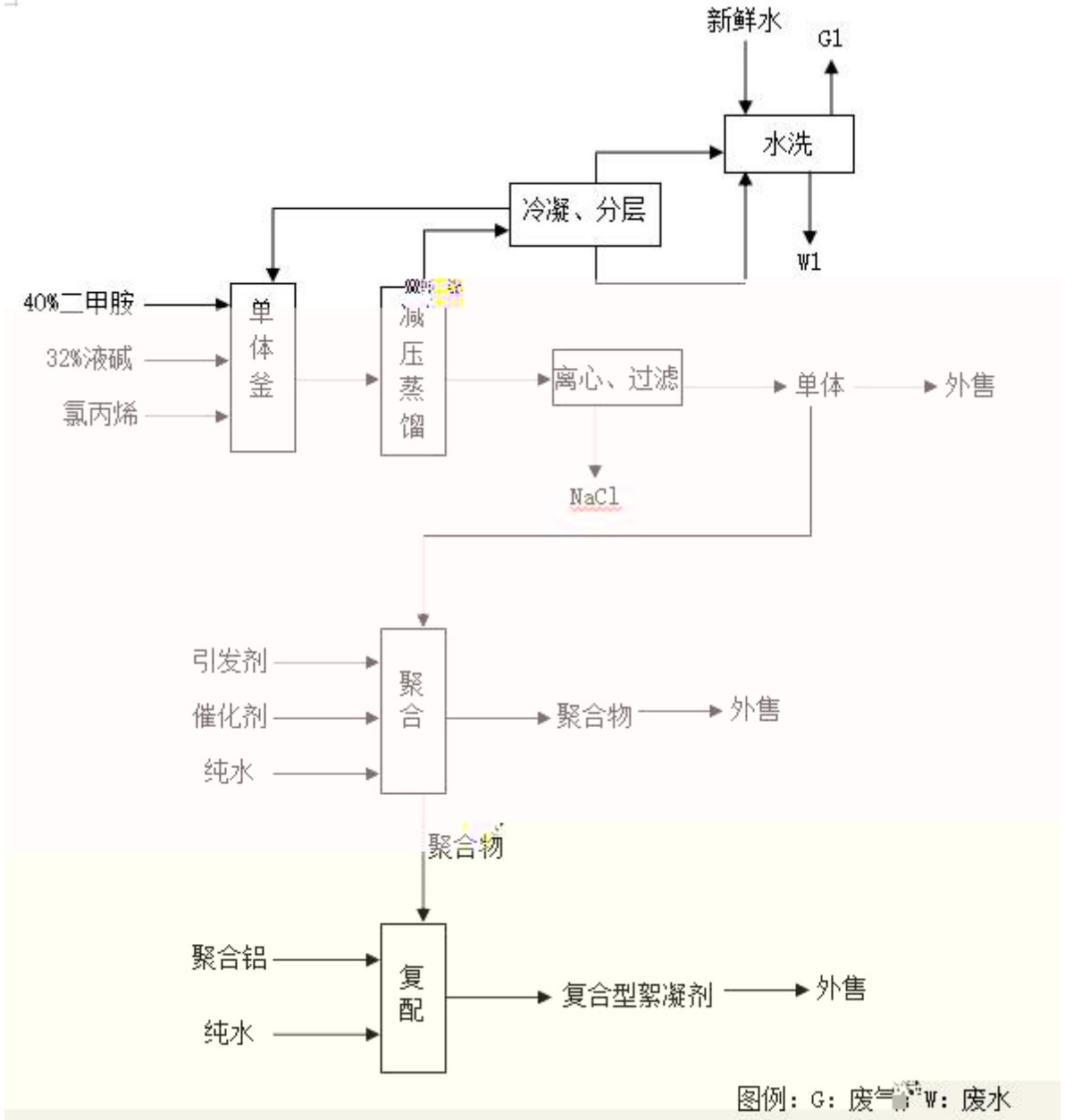

2.2-2

2.2-5

2.2-5

Cl₂

HCl

-

SO₂ NO_x

PO

C2-C3

CaCO₃ Mg(OH)₂ NaCl

25 /

12 / HCL

6 /

2 /

8 /

2 /

2000 /

2.2.7.1

1500 m³/a

DN500

1

5706.66m³/h

5271.86m³/h

2

12000m³/a



0.3m³/h

3

150

4828m³/h

4

2

2

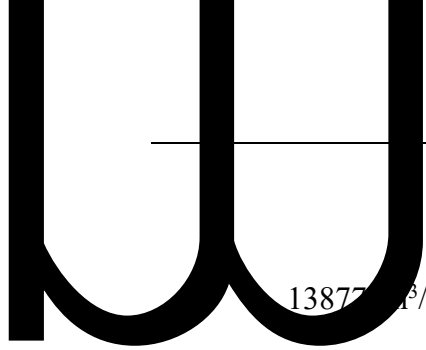

13877m³/a

3596.4m³/a

3862.4m³/a

81200m³/a

2400m³/a



			kcal/h				
					2		
	7 12		180		kcal/h 120 2		F22
	-5 5		150		kcal/h 108 2		
	5		65		kcal/h 100 2		
	-15		120		kcal/h 110 100 kcal/h 1		F22
	-15		65		kcal/h 100 2		

2.2.7.5

10 kW h

2.2.7.6

2000Nm³/h

5000Nm³/h

DN250

4435Nm³/min

892Nm³/h

2.2.8

2.2.8.1

PVC

2.2.8.2

2.2-6

2.2-6

			m ³
32%		3	3000
50%		3	3000
15%		2	3000
		2	287
		4	79
	PO	2	1000
		2	1000
		2	196
35%		3	1200
35%		1	400
50%		1	400
50%		1	400
		1	103
		1	103
		2	120
		1	20
		1	40
		1	40
		1	100
		1	50
		4	500
		2	300
		5	45
		8	60
		1	50
		1	35
40%			2
	1		20
	1		20
		2	20

2.2.10

2.2.10.1

1

2.2-7

2.2-7

		(m /h)		kg/h	t/a		m	m	
		14435		0.714	5.712		38	0.9	
			SO ₂	-	-				
			NO _x	1.331	10.648				
		10522		0.0552	0.4416		42	1.1	
			SO ₂	-	-				
			NO _x	0.87	6.96				
			VOCs	0.427	3.416				
				-	-				
		-	-						
		40147		0.386	3.088		40	1.0	
		41852		0.398			40	1.0	
		54029		0.516	4.128		15	1.0	

		41622		0.367	2.936		15	1.0	
		307		0.0016	0.0128		25	0.35	
		16741		-	-		30	1.0	
				-	-				
				-	-				
			VOCs	0.0658	0.5264				
		48027		0.502	4.016		15	0.9	
		25974		0.247	1.976		15	0.7	
		70672		0.662	5.296		15	1.0	
		92		0.0005	0.004		24	0.08	
				0.0002	0.0016				
			VOCs	-	-				
				0.0001	0.0008				
				0.0001	0.0008				
		130		0.0005	0.004		22	0.1	
			VOCs	0.0001	0.0008				
				0.00001	0.00008				
				0.0023	0.0184				
		2965		0.0138	0.1104		25	1.1	
			SO ₂	-	-				

			NOx	0.388	3.104				
		96		-	-		15	0.2	
				-	-				
			VOCs	0.0026	0.0208				
				0.0089	0.0712				
		111		0.0008	0.0064		15	0.25	
				0.656	5.248				
			VOCs	0.0028	0.0224				
				-	-				
				-	-				
				0.0011	0.0088				
		241	VOCs	0.00003	0.00024		20	0.5	
				-	-				
				-	-				
				-	-				
		389	VOCs	0.0005	0.004		20	0.5	
				0.0004	0.0032				
				-	-				
				-	-				

2.2-7

2.2-8

2.2-8

		t/a
1		30.88
2	NO _x	20.712
3	VOC _s	3.99
4		0.0168
5		0.0016
6		0.00088
7		0.0192
8		0.0712
9		0.0064
10		5.248
11		0.0088
12		0.0032

2

2.2-9

2.2-9

1	VOC _s	t/a	73.21
2		t/a	3.05
3		t/a	0.4
4	HCl	t/a	1.09
5		t/a	0.035
6		t/a	1.64
7		t/a	1.13
8		t/a	0.41
9		t/a	0.84

GB16297-1996 2

VOC_s

6

DB37/2801.6-2018

3

2.2.10.2

1

2.2-10

		15.2	COD SS	-	15.2	
		33.85	COD	-	33.85	
		142.6	COD		0	
		609.41				

2.2.10.3

1

2.2-11

2.2-11

t/a

8640 CaCO₃ Mg(OH)₂ NaCl

1

1m³/a

0.017

2

CaO 17000 CaCl₂ 40% SS 1%
Ca(OH)₂ 8% H₂O 50%
Mg(OH)₂ 1%

134 CaO CaCO₃

2.4 Fe

3

9623.31

40 8 Al₂O₃

			914.89		HW11	
			45.2		HW45	
			300		HW50	
			17.7		HW11	
			2068.42		HW11	
			3.5		HW08	
			6 3		HW49	
4			14		HW06	
			1 3		HW06	
			30		HW08	
			0.2			
			240			
5			33.68	-	-	
6			105	-	-	
7			6		HW49	
8			660t 20t			

2.2.10.4

2.2-12

2.2-29

1	25 /		7	80		70
			8	95		75
			2	95		75
			3	95		75
2	12 / HCL		6	95		75
			4	75		60
			3	85		70
			6	90		70
			4	85		70
			6	80		70
			1	100		80
			26	75		60
			21	75	60	
3	10 /		6	75	60	
			1	90	80	
			6	75	60	
4			2	95	65	
			2	95	65	
			14	80	70	
5			6	75	60	
			1	90	80	
			6	75	60	
6	PO		6	70	60	
			3	85	70	

			2	84		75
7			2	80		60
			5	90		75
			2	80		60
8			6	85		65

2019 8 26 8 27

2.2-13

2.2-13

	2018 8 26		dB A		2018 8 27		dB A	
1#	67.5		64.0		67.2		64.7	
2#	65.3		59.6		64.0		59.9	
3#	68.3		56.6		68.1		59.6	
4#	63.5		60.5		63.4		61.6	
5#	73.6		55.6		73.0		57.5	
6#	62.0		51.5		61.9		48.4	
7#	60.3		53.5		59.9		53.5	
8#	59.9		54.8		59.0		54.0	
9#	66.5		56.5		66.4		56.1	
10#	60.2		57.2		61.3		56.6	
11#	48.1		46.2		46.6		44.7	

2.2-13

GB12348-2008 3

2.2.10.5

2.2-14

2.2-14

1				t/a	30.88
2			NOx	t/a	20.712
3			VOCs	t/a	3.99
4				t/a	0.0168

5				t/a	0.0016
6				t/a	0.00088
7				t/a	0.0192
8				t/a	0.0712
9				t/a	0.0064
10				t/a	5.248
11				t/a	0.0088
12				t/a	0.0032
13			VOCs	t/a	73.21
14				t/a	3.05
15				t/a	0.4
16			HCl	t/a	1.09
17				t/a	0.035
18				t/a	1.64
19				t/a	1.13
20				t/a	0.41
21				t/a	0.84
22				m ³ /a	4875280
23			COD	t/a	292.52
24				t/a	39
25				t/a	3928.49
26				t/a	35804.67

2.3

2.3.1

40%

60%

CaCl₂

2019

2.3.2

2.3.2.

1		kg/h	28	--
			30	720h
		m ²	458.4	--
			2100	--
1			1900	--

2.3.2.4

2.3-4

2.3-4

		t
1		72
2		14.4
3		15.12
4		0.144
5		0.34

2.3.2.4

2.3-5

2.3-5

		kg/h
1		28

2.3.2.5

2.3.2.5.1

1

2

2.3.2.5.2

PVC

2018

PO



2.3.2.6

2.3-6

2.3-6

			L m		m ³		t	m	
TBHP/TBA			1.0 1.6	1	1.15	0.8	0.96		
TBHP/TBA			1.3 3.4	1	4.07	0.8	3.38		
TBHP/			0.6 1.6	1	0.38	0.8	0.32		
TBHP/			0.6 1.6	1	0.38	0.8	0.32		
			0.6 1.6	1	0.76	0.8	0.55		
			0.9 1.6	1	6.32	0.8	3.23		
			1.5 3.4	1	16.21	0.8	12.64		
TBA			2.2 4.6	1	8.14	0.8	6.35		
			1.8 3.4	1	3.59	0.7	3.59		
			1.2 1.8	1	3.59	0.7	3.59		
			0.6 0.8	1	1.99	0.8	1.11		
			1.2 1.8	1	0.17	0.6	0.12		
			2.4 5.0	1	1.99	0.8	1.42		
			1.2 1.8	1	20.98	0.8	15.06		
			15m ³	1	12.00	0.8	13.68		

2.3-7

1	1	200× 2100	1	
2	2	200× 2100	1	
3	3	200× 2100	1	
4	4	200× 2100	1	
5	5	200× 2100	1	
6	6	200× 2100	1	
7	7	250× 2400	1	
8	8	250× 2400	1	
9	9	250× 2400	1	
10	10	300× 2700	1	
11	11	300× 2700	1	
12		DN200× 6	1	
13	TBHP	DN250× 9	1	
14	TBHP	DN200× 2.2	2	
15	TBHP/TBA	1000 1600	1	
16	TBHP/TBA	1300 3400	1	
17	TBHP/	600 1600	1	
18	TBHP/	600 1600	1	
19		1500 2400	1	
20		900 1600	1	
21		1500 3400	1	
22	TBA	2200 4600	1	
23		1800 3400	1	
24		1500 2400	1	
25	V-2203	DN250× 2000	1	
26		DN250× 1250	1	
27		DN250× 1250	1	
28	V-2203	20m 0.06m ³ /h	1	

29	V-2203	45m 1.45m ³ /h	1	
30	V-2301	45m 1.45m ³ /h	1	
31	V-2302	20m 0.06m ³ /h	1	
32	TBHP/	650m 0.005m ³ /h	6	
33		20m 0.05m ³ /h	1	
34	TBA/TBHP	20m 0.07m ³ /h	1	
35		530m 0.04m ³ /h	1	
36	TBA	640m 0.25m ³ /h	1	
37	TBA	35m 0.009m ³ /h	1	
38	TBA	35m 0.014m ³ /h	1	
39	TBA	650m 0.006m ³ /h	5	
40		50m 5m ³ /h	1	
41		V=2m ³	1	
42		1200 1800	1	
43		1200 1800	1	
44		600 800	1	
45		1200 1800	1	
46		2400 5000	1	
47		--	1	
48		--	1	
49		--	1	
50		--	1	
51		760m 0.3m ³ /h	1	
52		120m 6.7m ³ /h	1	
53		100m 0.35m ³ /h	2	
54		40m 50m ³ /h	1	

55		15m ³	1	
56			1	
57			1	

2.3.3

2.3.3.1

1

1

1.75m³/d 52.5m³

2 -----

----- 2.4m³/d 72m³

124.5m³

2

1

90% 47.25m³ ----- 72m³

119.25m³

2

SH3015-2003

15mm 30mm

Q m³

F

0.9

i mm

			350m ²	30mm
0.9				
		94.5m ³		5400m ³
	2.3-2			2.3-3
2.3.3.2				
	70kg/h	TBHP		
		70kg/h	3.0MPa	260
	1 240t/h			1 260t/h
2.3.3.3				
			2m ³ /h	-25
2.3.3.4				
	2.16	kW h		
2.3.3.5				
			6	6
5	429Nm ³ /min		420Nm ³ /min	
	2950Nm ³ /h	148Nm ³ /h		
	140Nm ³ /h			
2.3.4				
2.3.5				
2.3.6				
1				

TBHP

1

2.3-10

2.3-10

				kg/h	t
G2-1		VOCs		7	5.04
		VOCs TBA		3	2.16
G2-2		VOCs		61	43.92
G2-3	TBHP			0.7	0.504
				0.3	0.216
		VOCs TBA		1	0.72
G2-4				20.5	14.76
		VOCs		7.5	5.4

2.3-11

2.3-11

1	VOCs	t	72.72	72.72
2		t	0.504	0.504
3		t	0.216	0.216
4		t	14.76	14.76

2

①

VOCs

VOCs

VOCs

2015

104

.3

LDAR

$$VOCs \text{ 排 放 量 } = N \times F_A \times WF_{TOC} \times \frac{WF_{VOC}}{WF_{TOC}} \times$$

$$\frac{WF_{VOCs}}{WF_{TOC}} \text{ TOC VOCs } 1$$

2.3-12

2.3-12

	TOC kg/ h	TOC	t h	VOCs t
205	0.00403	80%	720	0.476
226		100%	720	0.656
10	0.0199	80%	720	0.115
12		100%	720	0.172
3	0.104	80%	720	0.179
4		100%	720	0.299
455	0.00183	80%	720	0.479
916		100%	720	1.206
4	0.0017	80%	720	0.0039
4		100%	720	0.0049
1	0.015	80%	720	0.00864
4		100%	720	0.0432
				3.64264

LDAR

99% VOCs 0.036t

a.

2015 104

.3

$$L_T = L_S + L_W$$

lb/a

lb/a

lb/a

i.

$$L_S = 365 K_E \left(\frac{\pi D^2}{4} \right) H_{VO} K_S W_T$$

lb/a

ft

ft³

lb/ft³

ii.

$$L_W = \frac{5.614}{RT_{LA}} M_V P_{VA} Q K_N K_P K_B$$

lb/a

lb/lb-mol

psia

bbbl/a

2.3-14

b.

VOCs

2015 104 .3

$$E_{\text{装卸}} = \frac{L_L \times V}{1000}$$

kg/m³

$$L_L = C_0 \times S$$

kg/m³

2.3-13

2.3-13

	kPa)			Btu/ft ² day	m ³	m	/	pa	m	m	t/y	t	t/y	t/y
	101	36	12	1547	10.18	1.8			3.4	0.4	0.079	18	0.0113	0.09
	101	36	12	1235.7	2.49	1.2			1.8	1.2	0.0124	72	0.0466	0.059
	101	36	12	1232.53	7.9	1.6			3.4	2.5	0.03	14.4	0.0455	0.039

2.3-14

	P _T Pa	kg/m ³	g/mol			s	t/a	^N m ³ /a	t/a
	4080	780	64			0.6	18	23	0.00867
	160000	560	58			0.6	72	94	0.035
	1023000	510	42			0.6	14.4	19	0.0069

2

1

TBA

TBHP

TBA

6m

99%

VOCs(

TBA)

99.8%

2.3-15

2.3-15

			m ³ /h	mg/m ³	kg/h	t	kg/h	mg/m ³
1		VOCs	45000	20.14	0.202	0.145	3.0	60
			45000	0.7	0.0007	0.00504	/	50
			45000	0.7	0.0003	0.00216	/	50
			45000	0.91	0.0041	0.02952	/	1

2.3-19 VOCs

6

1

VOCs

6

2

2

GB31571-2015

GB37822-2019

a

+

b

.

VOCs

VOCs

TBHP/TBA

104.4t/a

0.05057t/a

6

DB37/2801.6-2018

1

VOCs

VOCs

VOCs

VOCs

1844

2.3-16

2.3-16

			t		t
1		VOCs	3.64264	99%	0.036
2		VOCs	0.23857	20%	0.191

3

2.3-17

2.3-17

		kg/h	t	
	VOCs	0.202	0.145	h=6m =1.5m
	VOCs	--	0.227	--

2.3-18

2.3-18

		t/a
1		5.712
2	SO ₂	-
3	NO _x	10.648
4		0.4416
5	SO ₂	-
6	NO _x	6.96
7	VOCs	3.416
8		-
9		-
10		3.088
11		3.176
12		

2.3.9.3

90% 47.25m³ 72m³
 119.25m³

2.3-19

2.3-19

			m ³				m ³	
-			52.5	COD			47.25	
				SS				
--			72	--			72	
			124.5	--	--	--	119.25	--

2.3-23

119.25m³

COD 1500mg/L

450mg/L

COD 0.0072t 0.00095t

2.3-20

2.3-20

		m ³ /h	(mg/L,PH)		m ³ /h	
		6.2	PH COD SS		6.2	
		2.26	COD SS		0	
		1.08	78%		0	
	H ₂	1.2	COD		0	
		20	COD	PO	20	
		30	COD	PO	30	
		39.5	PH		0	
		11	PH		0	
		45m ³ /	Na ₂ CO ₃ :10 30%		0	(7 8)
		13.85	PH COD		13.85	
PO		480	COD		480	
		2			2	
		6	COD		2	
		2.58	COD		2.58	
		4	COD		4	

		15.273	COD SS	-	15.265	
		33.95	COD	-	33.95	
		142.6	COD		0	
		609.583				

2.3.9.4

2.3-21

2.3-22

2.3-21

1 TBHP/TBA HW49

			45.2		HW45	
			300		HW50	
			17.7		HW11	
			2068.42		HW11	
			3.5		HW08	
			6 3		HW49	
4			14		HW06	
			1 3		HW06	
			30		HW08	
			0.2			
			240			
5			33.68	-	-	
6			105	-	-	
7			6		HW49	
8			660t 20t			
9	PO/TBA	TBHP/TBA	41.09	TBHP TBA	HW49	

2.3.9.5

2.3-23

2.3-23

		dB	A	
1		75~80	11	70~75
2		75~80	1	70~75
3	TBHP	75~80	1	70~75

1	25	/	7	80	70
			8	95	75
			2	95	75
			3	95	75
			6	95	75
			4	75	60
2	12	/	3	85	70
			6	90	70
			4	85	70
			6	80	70
			1	100	80
			26	75	60
3	10	/	21	75	60
			4	105	80

9		11	80	60
10		1	80	60
11	TBHP	1	80	60
12	TBHP	1	80	60
13		4	90	70
14		4	90	70
15	PO/TBA	7	90	70
16		1	90	70
17		11	90	70
18		1	80	60
19		1	80	60
20		1	80	60
21		1	80	60

			t/a	0.00216
			t/a	0.02952
		VOCs	t/a	0.227
			t/a	119.25
		COD	t/a	0.0072
			t/a	0.00095
			t/a	41.09

2.3-27

2.3-27

	t/a	30.88	0	0	30.88	0
NOx	t/a	20.712	0	0	20.712	0
VOCs	t/a	3.99	0	0.145	4.135	0.145
	t/a	0.0168	0	0	0.0168	0
	t/a	0.0016	0	0	0.0016	0
	t/a	0.00088	0	0	0.00088	0
	t/a	0.0192	0	0	0.0192	0
	t/a	0.0712	0	0	0.0712	0
	t/a	0.0064	0	0	0.0064	0
	t/a	5.248	0	0	5.248	0
	t/a	0.0088	0	0	0.0088	0
	t/a	0.0032	0	0	0.0032	0
VOCs	t/a	73.21	0	0.227	73.437	0.227
	t/a	3.05	0	0	3.05	0
	t/a	0.4	0	0	0.4	0
HCl	t/a	1.09	0	0	1.09	0
	t/a	0.035	0	0	0.035	0
	t/a	1.64	0	0	1.64	0
	t/a	1.13	0	0	1.13	0
	t/a	0.41	0	0	0.41	0

		t/a	0.84	0	0	0.84	0
		m ³ /a	4875280	0	119.25	4875399.25	119.25
	COD	t/a	292.52	0	0.0072	2929.5272	0.0072
		t/a	39	0	0.00095	39.00095	0.00095
		t/a	3928.49	0	41.09	3876.19	41.09
		t/a	35804.67	0	0	93696.06	0

2.4

2.4.1

1

40%

60%

CaCl₂

2

1

2

3

4

1

2

3

4

5

6

7

8

2.4.2

2.4.3

1

2

3

		2		
2.1				
2007	3	15	18	
		()	1968
1970				
9		82.46	2300	
				PO/PG
	GB/T 19001	GB/T 24001	GB/T 28001	
2010		254.62	54.84	27.13

2.2

2.2.1

25 / 20 / 12

/ VCM

HCL 15 / 6 /

3 / 8 / 2 /

8 /

2 / 2000 /

2.2.2

2.2-3

2.2-3

1		25 /	32% 25 t/a 100%
			0000t/a 100% 0000t/a 100%
			3 t/a
			PO 6 t/a
			2 t/a
			2.0 /
			2000 / 2000 /
2			2

3			
4			

kW h

200t/h 0.89MPa 200
0.8MPa 129.18t/h

2

2

1000m³/

6

P-1001ABC

3

750m³/h P-1001D

1

288m³/h P-2001AB

2

1000m³/h

4000m³/h

3

2000Nm³/h

5000Nm³/h

DN250

4435Nm³/min

892Nm³/h

4

PVC

PO

5400m³

2.2.3

560778.319m²

3

1

1

1

PVC

2.2-1

2.2.4

2.2-4

2.2-4

t/a

1	32%	247225
2	50%	40000
3		5809
4	31%	20760
5	75%	2402
6		29851
7		5585
8		5908
9		7700
10		100000
11		100000
12		942500
13		60000
14		10000
15		

17		20000	
18	POP	80000	
19		20000	
20		2000	

2.2.5

4

2.2-1

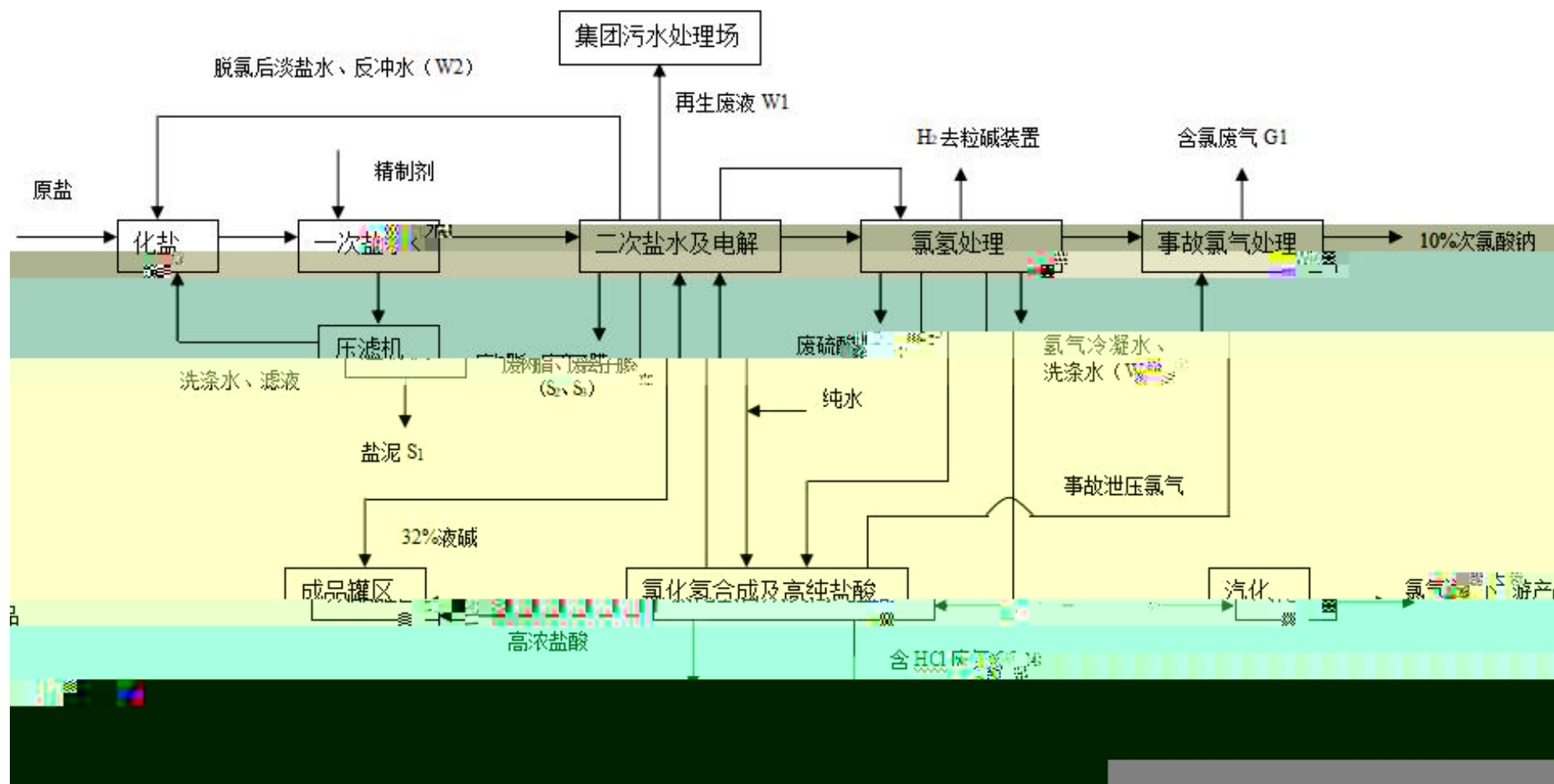

5

32%

50%

2.2-2

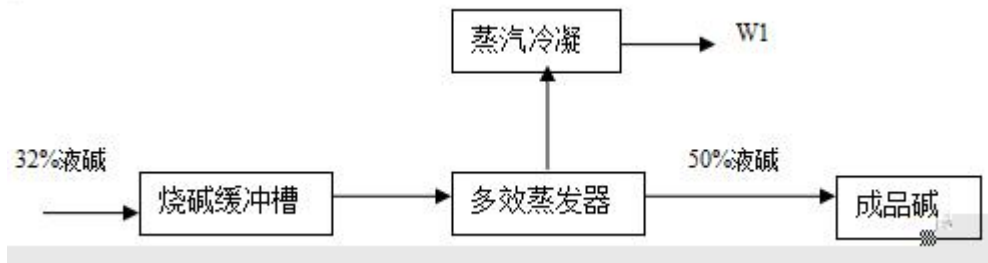

6

50%

50%

97.5 97.8%

62%

97.8%

2.2-3

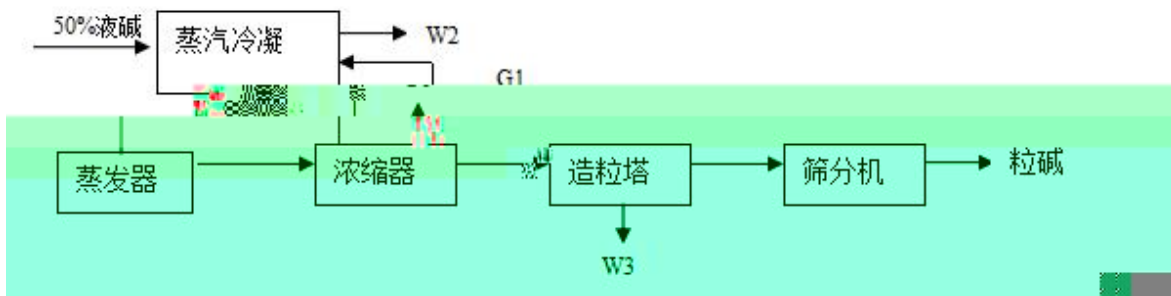

4

2.2-4

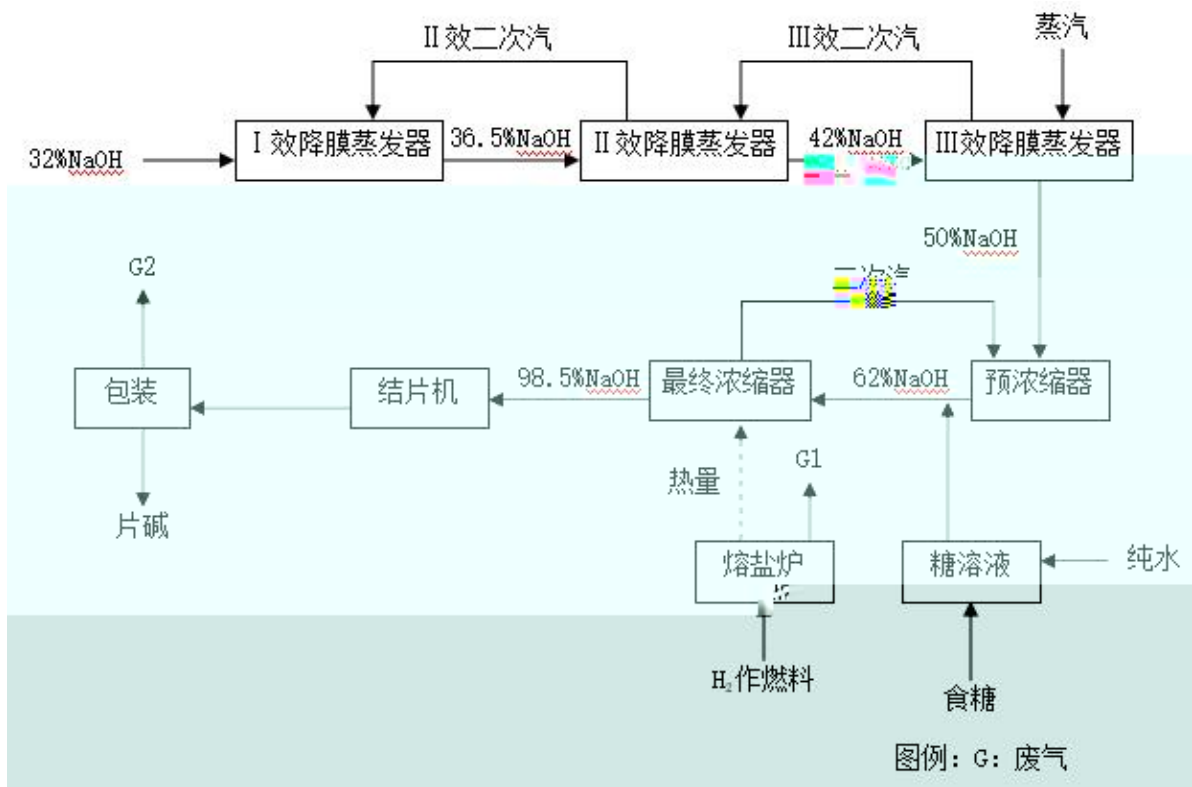

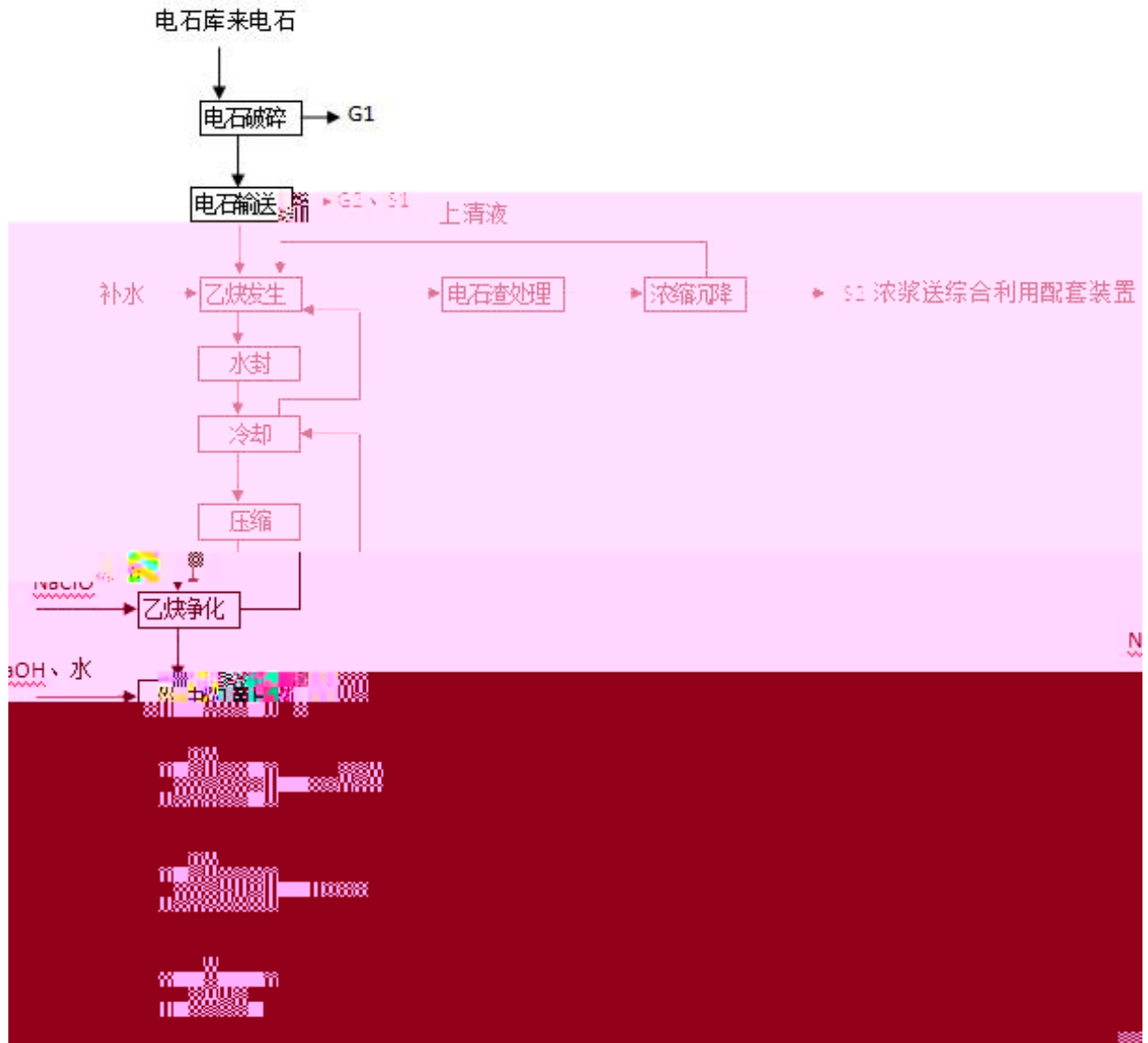

Ca(OH)₂

2.2-6

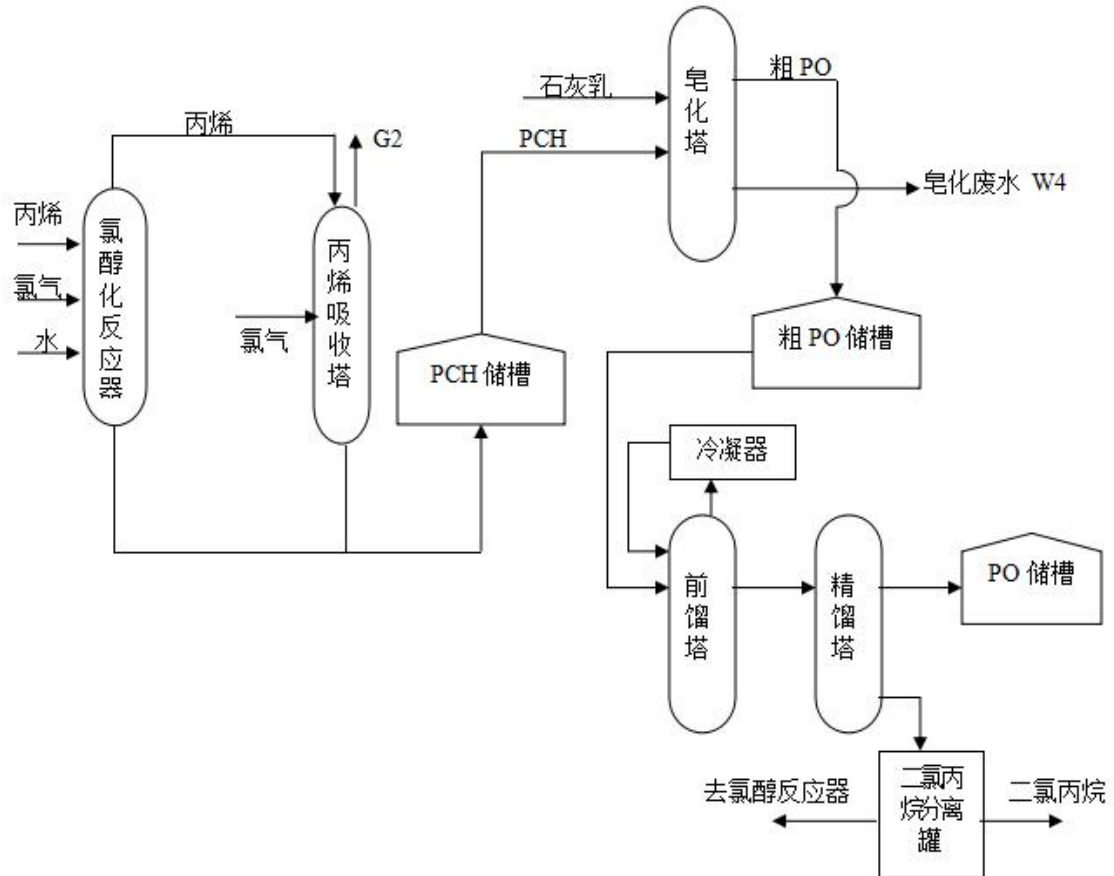

2.2-6

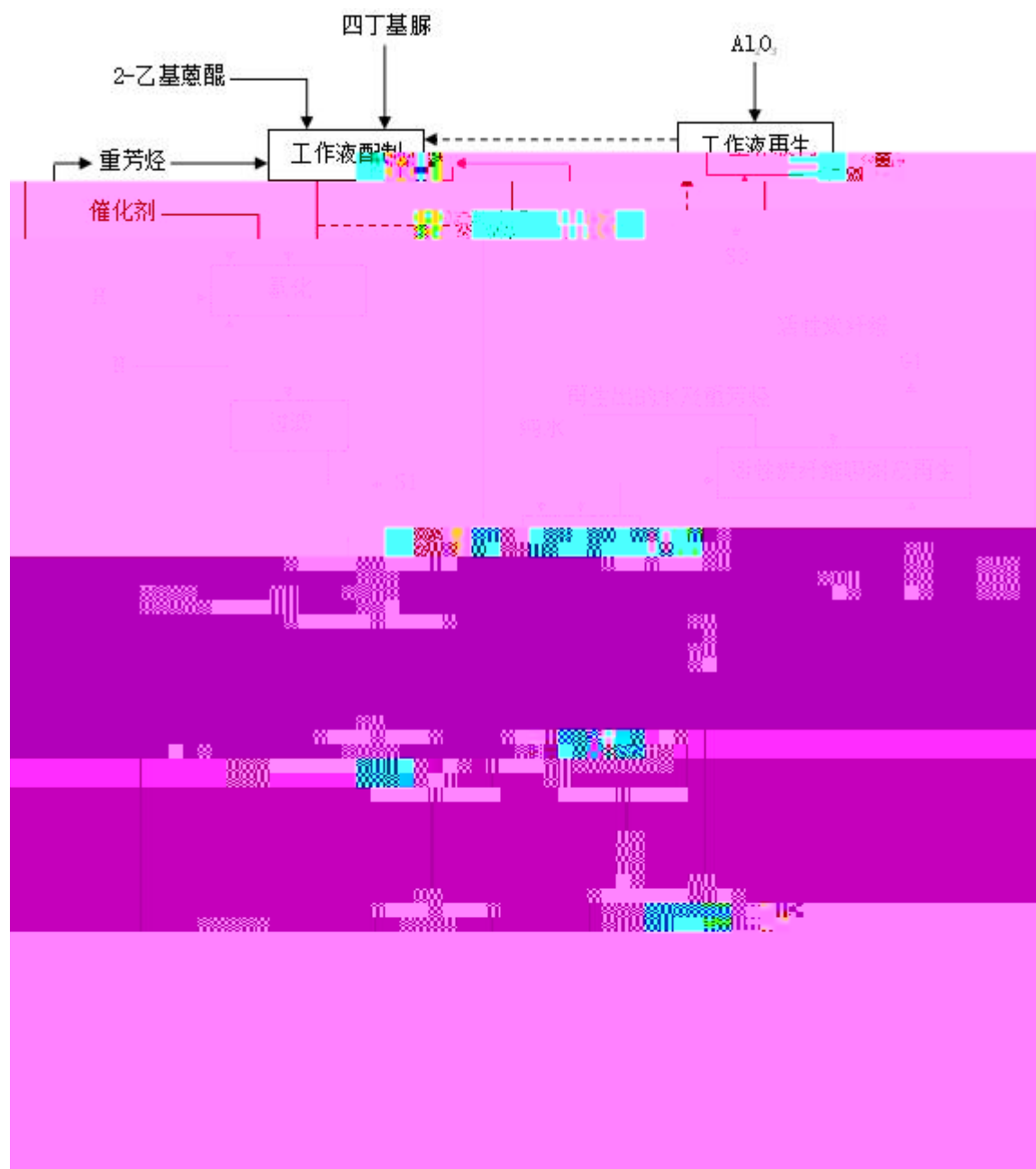

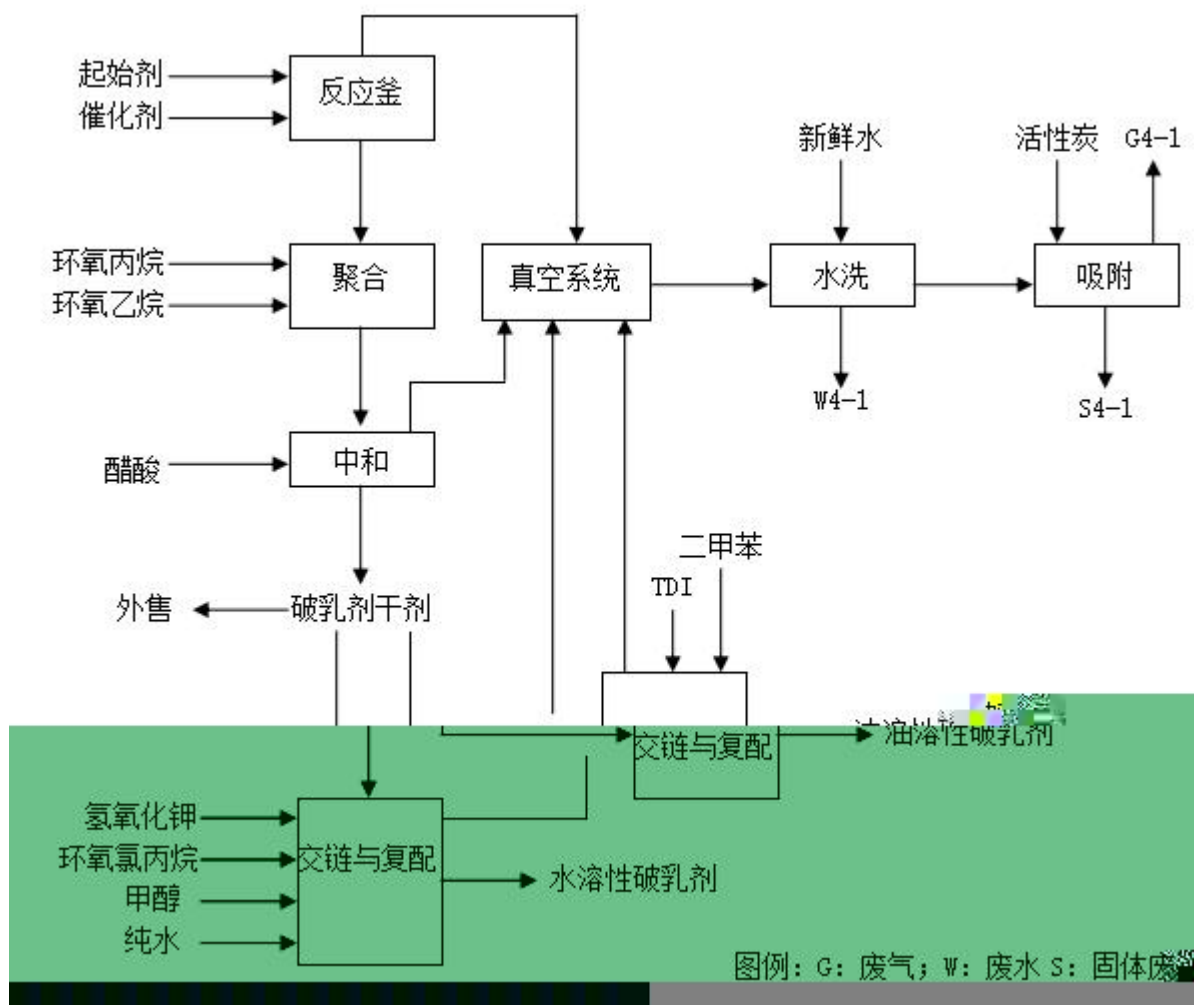

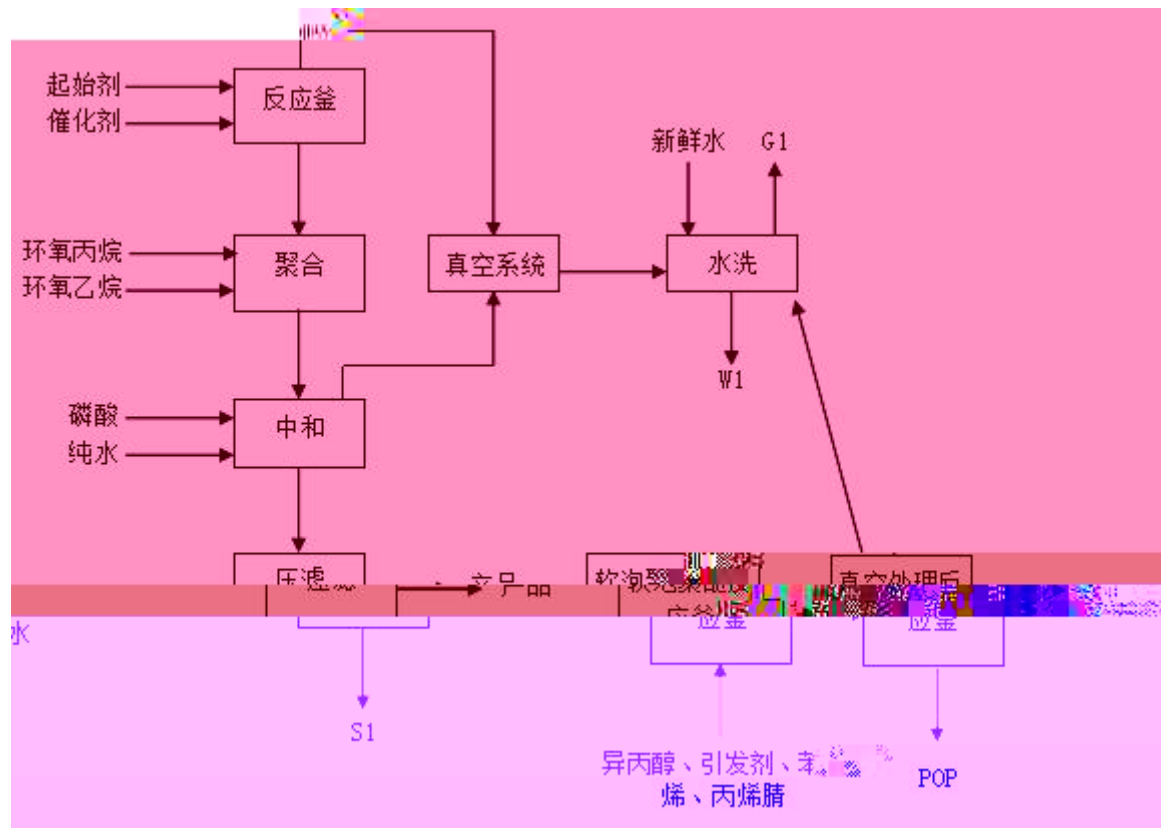

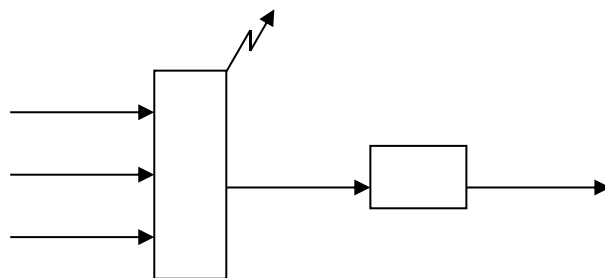
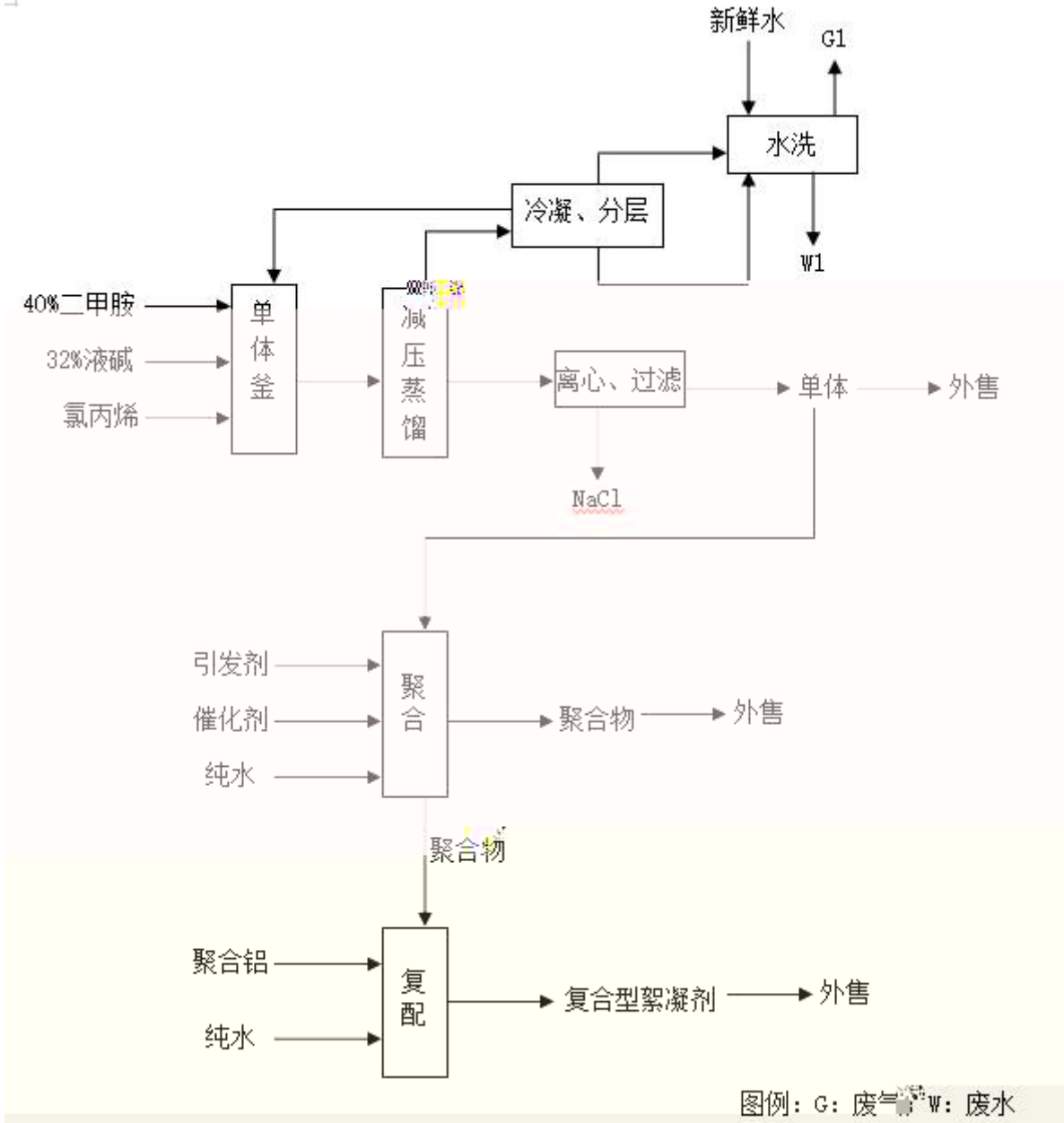

2.2-2

2.2-5

2.2-5

Cl₂

HCl

-

SO₂ NO_x

PO

C2-C3

CaCO₃ Mg(OH)₂ NaCl

25 /

12 / HCL

6 /

2 /

8 /

2 /

2000 /

100

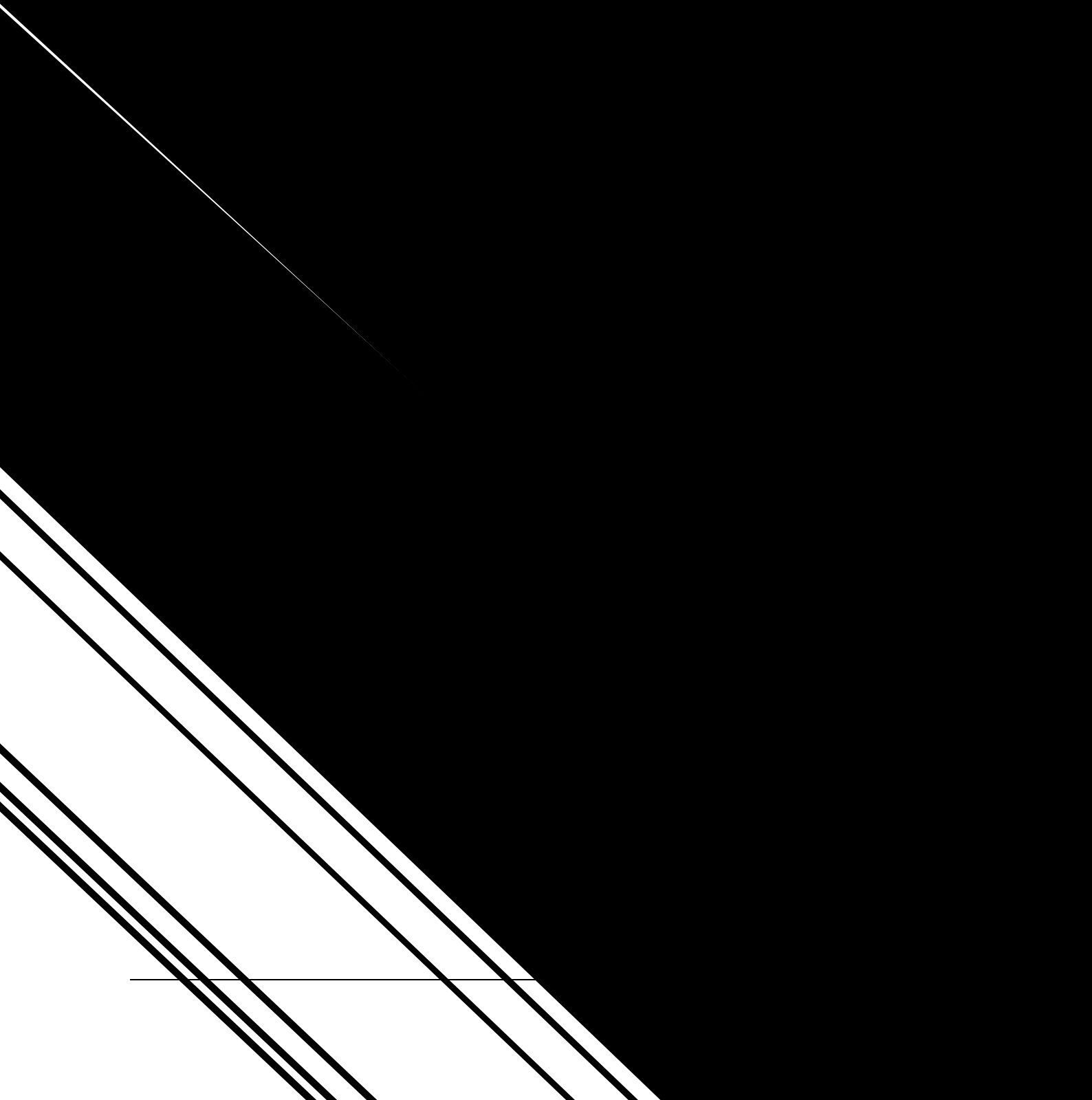

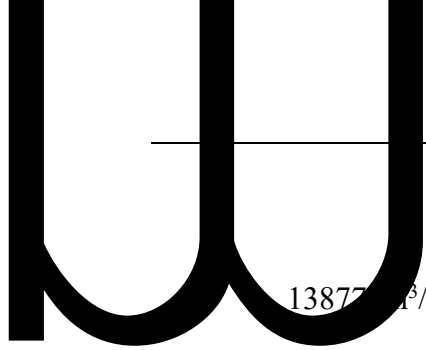

13877m³/a

3596.4m³/a

3862.4m³/a

81200m³/a

2400m³/a



			kcal/h				
					2		
	7 12		180		kcal/h 120 2		F22
	-5 5		150		kcal/h 108 2		
	5		65		kcal/h 100 2		
	-15		120		kcal/h 110 100 kcal/h 1		F22
	-15		65		kcal/h 100 2		

2.2.7.5

10 kW h

2.2.7.6

2000Nm³/h

5000Nm³/h

DN250

4435Nm³/min

892Nm³/h

2.2.8

2.2.8.1

PVC

2.2.8.2

2.2-6

2.2-6

			m ³
32%		3	3000
50%		3	3000
15%		2	3000
		2	287
		4	79
	PO	2	1000
		2	1000
		2	196
35%		3	1200
35%		1	400
50%		1	400
50%		1	400
		1	103
		1	103
		2	120
		1	20
		1	40
		1	40
		1	100
		1	50
		4	500
		2	300
		5	45
		8	60
		1	50
		1	35
40%			2
	1		20
	1		20
		2	20

2.2.10

2.2.10.1

1

2.2-7

2.2-7

		(m /h)		kg/h	t/a		m	m	
		14435		0.714	5.712		38	0.9	
			SO ₂	-	-				
			NO _x	1.331	10.648				
		10522		0.0552	0.4416		42	1.1	
			SO ₂	-	-				
			NO _x	0.87	6.96				
			VOCs	0.427	3.416				
				-	-				
		-	-						
		40147		0.386	3.088		40	1.0	
		41852		0.398			40	1.0	
		54029		0.516	4.128		15	1.0	

		41622		0.367	2.936		15	1.0	
		307		0.0016	0.0128		25	0.35	
		16741		-	-		30	1.0	
				-	-				
				-	-				
			VOCs	0.0658	0.5264				
		48027		0.502	4.016		15	0.9	
		25974		0.247	1.976		15	0.7	
		70672		0.662	5.296		15	1.0	
		92		0.0005	0.004		24	0.08	
				0.0002	0.0016				
			VOCs	-	-				
				0.0001	0.0008				
				0.0001	0.0008				
		130		0.0005	0.004		22	0.1	
			VOCs	0.0001	0.0008				
				0.00001	0.00008				
				0.0023	0.0184				
		2965		0.0138	0.1104		25	1.1	
			SO ₂	-	-				

			NOx	0.388	3.104				
		96		-	-		15	0.2	
				-	-				
			VOCs	0.0026	0.0208				
				0.0089	0.0712				
		111		0.0008	0.0064		15	0.25	
				0.656	5.248				
			VOCs	0.0028	0.0224				
				-	-				
				-	-				
				0.0011	0.0088				
		241	VOCs	0.00003	0.00024		20	0.5	
				-	-				
				-	-				
				-	-				
		389	VOCs	0.0005	0.004		20	0.5	
				0.0004	0.0032				
				-	-				
				-	-				

2.2-7

2.2-8

2.2-8

		t/a
1		30.88
2	NO _x	20.712
3	VOC _s	3.99
4		0.0168
5		0.0016
6		0.00088
7		0.0192
8		0.0712
9		0.0064
10		5.248
11		0.0088
12		0.0032

2

2.2-9

2.2-9

1	VOC _s	t/a	73.21
2		t/a	3.05
3		t/a	0.4
4	HCl	t/a	1.09
5		t/a	0.035
6		t/a	1.64
7		t/a	1.13
8		t/a	0.41
9		t/a	0.84

GB16297-1996 2

VOC_s

6

DB37/2801.6-2018

3

2.2.10.2

1

2.2-10

2.2-10

		m ³ /h	(mg/L,PH)		m ³ /h	
		6.2	PH COD SS		6.2	
		2.26	COD SS		0	
		1.08	78%		0	
	H ₂	1.2	COD		0	
		20	COD	PO	20	
		30	COD	PO	30	
		39.5	PH		0	
		11	PH		0	
		45m ³ /	Na ₂ CO ₃ :10 30%		0	(7 8)
		13.85	PH COD		13.85	
PO		480	COD		480	
		2			2	
		6	COD		2	
		2.58	COD		2.58	
		4	COD		4	

		15.2	COD SS	-	15.2	
		33.85	COD	-	33.85	
		142.6	COD		0	
		609.41				

2.2.10.3

1

2.2-11

2.2-11

			t/a			
1			8640	CaCO ₃ Mg(OH) ₂ NaCl		
			1m ³ /a			
			0.017			
2			CaO 17000	CaCl ₂ 40% SS 1% Ca(OH) ₂ 8% H ₂ O 50% Mg(OH) ₂ 1%		
			134	CaO CaCO ₃		
3			2.4	Fe		
			9623.31			
			40 8	Al ₂ O ₃		
			526.48		HW45	

			914.89		HW11	
			45.2		HW45	
			300		HW50	
			17.7		HW11	
			2068.42		HW11	
			3.5		HW08	
			6 3		HW49	
4			14		HW06	
			1 3		HW06	
			30		HW08	
			0.2			
			240			
5			33.68	-	-	
6			105	-	-	
7			6		HW49	
8			660t 20t			

2.2.10.4

2.2-12

2.2-29

1	25 /		7	80		70
			8	95		75
			2	95		75
			3	95		75
2	12 / HCL		6	95		75
			4	75		60
			3	85		70
			6	90		70
			4	85		70
			6	80		70
			1	100		80
			26	75		60
			21	75		60
3	10 /		6	75		60
			1	90		80
			6	75		60
4			2	95		65
			2	95		65
			14	80		70
5			6	75		60
			1	90		80
			6	75		60
6	PO		6	70		60
			3	85		70

			2	84		75
7			2	80		60
			5	90		75
			2	80		60
8			6	85		65

2019 8 26 8 27

2.2-13

2.2-13

	2018 8 26		dB A		2018 8 27		dB A	
1#	67.5		64.0		67.2		64.7	
2#	65.3		59.6		64.0		59.9	
3#	68.3		56.6		68.1		59.6	
4#	63.5		60.5		63.4		61.6	
5#	73.6		55.6		73.0		57.5	
6#	62.0		51.5		61.9		48.4	
7#	60.3		53.5		59.9		53.5	
8#	59.9		54.8		59.0		54.0	
9#	66.5		56.5		66.4		56.1	
10#	60.2		57.2		61.3		56.6	
11#	48.1		46.2		46.6		44.7	

2.2-13

GB12348-2008 3

2.2.10.5

2.2-14

2.2-14

1				t/a	30.88
2			NOx	t/a	20.712
3			VOCs	t/a	3.99
4				t/a	0.0168

5		t/a	0.0016
6		t/a	0.00088
7		t/a	0.0192
8		t/a	0.0712
9		t/a	0.0064
10		t/a	5.248
11		t/a	0.0088
12		t/a	0.0032
13	VOCs	t/a	73.21
14		t/a	3.05
15		t/a	0.4
16	HCl	t/a	1.09
17		t/a	0.035
18		t/a	1.64
19		t/a	1.13
20		t/a	0.

2.3.2

2.3.2.1

PO/TBA

TBHP

28kg/h

2100

25.3

1.2%

458.4m²

720h

3

2.3.2.2

2.3-1

2.3-1

	TBHP	TBHP	TBHP
		TBHP/	
		1 240t/h	70kg/h
		1 260t/h	

		2m ³ /h	-25
			2.16
		kW h	
		148Nm ³ /h 140Nm ³ /h	
		4	
		6m	
			--
		TBHP/TBA	--
			--
		5400m ³	--

2.3-2

2.3-2

		136m ³	
		70kg/h	
		1 240t/h	1 260t/h
		2m ³ /h	-25
1		6	6
		5	429Nm ³ /min
		420Nm ³ /min	2950Nm ³ /h
		148Nm ³ /h	
		140Nm ³ /h	

2.3.2.3

2.3-3

2.3-3

1		kg/h	28	--
			30	720h
		m ²	458.4	--
			2100	--
1			1900	--

2.3.2.4

2.3-4

2.3-4

		t
1		72
2		14.4
3		15.12
4		0.144
5		0.34

2.3.2.4

2.3-5

2.3-5

		kg/h
1		28

2.3.2.5

2.3.2.5.1

1

2

2.3.2.5.2

PVC

2018

PO

2.3-1

2.3.2.6

2.3-6

2.3-6

		L	m		m ³		t	m	
TBHP/TBA	>	1.0	1.6	1	1.15	-40	0.1Mpa	0.8	0.96
TBHP/TBA	# 5Z, YSä S>ö	1.3	3.4	1	4.07	-40	0.1Mpa	0.8	3.38

0.1 Mpa M

2.3-7

1	1	200× 2100	316L	1	
2	2	200× 2100	316L	1	
3	3	200× 2100	316L	1	
4	4	200× 2100	316L	1	
5	5	200× 2100	316L	1	
6	6	200× 2100	316L	1	
7	7	250× 2400	316L	1	
8	8	250× 2400	316L	1	
9	9	250× 2400	316L	1	
10	10	300× 2700	316L	1	
11	11	300× 2700	316L	1	
12		DN200× 6	316L	1	
13	TBHP	DN250× 9	316L	1	
14	TBHP	DN200× 2.2	316L	2	
15	TBHP/TBA	1000 1600	316L	1	
16	TBHP/TBA	1300 3400	316L	1	
17	TBHP/	600 1600	316L	1	
18	TBHP/	600 1600	316L	1	
19		1500 2400		1	
20		900 1600	316L	1	
21		1500 3400		1	
22	TBA	2200 4600	304	1	
23		1800 3400	316L	1	
24		1500 2400		1	
25	V-2203	DN250× 2000	2205 S30408	1	
26		DN250× 1250	2205 S30408	1	
27		DN250× 1250	2205	1	

			S30408		
28	V-2203	20m 0.06m ³ /h		1	
29	V-2203	45m 1.45m ³ /h		1	
30	V-2301	45m 1.45m ³ /h		1	
31	V-2302	20m 0.06m ³ /h		1	
32	TBHP/	650m 0.005m ³ /h	2205 S30408	6	
33		20m 0.05m ³ /h		1	
34	TBA/TBHP	20m 0.07m ³ /h		1	
35		530m 0.04m ³ /h		1	
36	TBA	640m 0.25m ³ /h		1	
37	TBA	35m 0.009m ³ /h		1	
38	TBA	35m 0.014m ³ /h		1	
39	TBA	650m 0.006m ³ /h		5	
40		50m 5m ³ /h		1	
41		V=2m ³	316L	1	
42		1200 1800	316L	1	
43		1200 1800	316L	1	
44		600 800	316L	1	
45		1200 1800	316L	1	
46		2400 5000		1	
47		--	316L	1	
48		--	304	1	
49		--	316L	1	
50		--	316L	1	
51		760m 0.3m ³ /h		1	
52		120m 6.7m ³ /h	316L	1	

53		100m 0.35m ³ /h	316L 20#	2	
54		40m 50m ³ /h	316L 20#	1	
55		15m ³	20#	1	
56				1	
57				1	
				68	

2.3.3

2.3.3.1

1

1

1.75m³/d 52.5m³

2 -----

----- 2.4m³/d 72m³

124.5m³

2

1

90% 47.25m³ ----- 72m³

119.25m³

2

SH3015-2003

15mm 30mm

	Q		m ³		
	F				
			0.9		
	i		mm		
				350m ²	30mm
	0.9				
				94.5m ³	5400m ³
		2.3-2			2.3-3
2.3.3.2					
		70kg/h	TBHP		
			70kg/h	3.0MPa	260
		1 240t/h			1 260t/h
2.3.3.3					
				2m ³ /h	-25
2.3.3.4					
		2.16	kW h		
2.3.3.5					
				6	6
5		429Nm ³ /min		420Nm ³ /min	
		2950Nm ³ /h	148Nm ³ /h		
		140Nm ³ /h			
2.3.4					
			TBHP		

1

TBHP

TBA

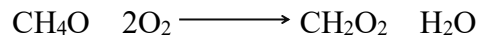
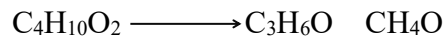
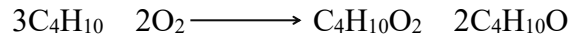

5.0MPa

3.0MPa 137

TBA TBHP

TBA

2 TBHP

1

TBA

(TBHP)

TBA

TBHP

TBA

TBHP

2

TBHP

TBA

(TBHP)

TBA

TBHP

60%

TBHP

TBHP

TBA

3 TBHP

TBHP

TBHP

TBHP/TBA

TBHP

TBHP/

3

TBA

PO



TBHP/

2



TBHP



TBHP

99%

PO

85%

C_3H_6 $C_4H_{10}O_2$

C_3H_6O $C_4H_{10}O$

C_3H_6 H_2O

C_3H_8O

C_3H_6O H_2O

$C_3H_8O_2$

$C_3H_8O_2$ $C_4H_{10}O$

$C_7H_{16}O_2$ H_2O

$C_4H_{10}O$ CH_2O_2

$C_5H_{10}O_2$ H_2O

TBHP/

11

135

135

2#-6#



	G2-1			TBA	
	G2-2				
	G2-3	TBHP		TBA	
	G2-4			PO	
	W2-1			COD SS	
				--	
	S2-1		TBA TBHP	TBA TBHP	

2.3.5

2.3-9

2.3-5

2.3-9

PO/TBA

		kg/h		kg/h
1		100	TBHP TBA	57.07
2		20	G2-1	11
3		21	G2-2	61
4		0.17	G2-3TBHP	2
5	TBA	18	G2-4	28
6	--	--	TBHP	0.1
	--	159.17	--	159.17

2.3.6

1

TBHP

1

2.3-10

2.3-10

				kg/h	t
G2-1		VOC _s		7	5.04
		VOC _s TBA		3	2.16
G2-2		VOC _s		61	43.92
G2-3	TBHP			0.7	0.504
				0.3	0.216
		VOC _s TBA		1	0.72
G2-4				20.5	14.76
		VOC _s		7.5	5.4

2.3-11

2.3-11

1	VOC _s	t	72.72	72.72
2		t	0.504	0.504

2

C

$\frac{WF_{VOCs}}{WF_{TOC}}$ TOC VOCs

1

2.3-12

2.3-12

		TOC kg/ h	TOC	t h	VOCs t
	205	0.00403	80%	720	0.476
	226		100%	720	0.656
	10	0.0199	80%	720	0.115
	12		100%	720	0.172
	3	0.104	80%	720	0.179
	4		100%	720	0.299
	455	0.00183	80%	720	0.479
	916		100%	720	1.206
	4	0.0017	80%	720	0.0039
	4		100%	720	0.0049
	1	0.015	80%	720	0.00864
	4		100%	720	0.0432
					3.64264

LDAR

99%

VOCs

0.036t

a.

VOCs

2015 104

.3

$$L_T = L_S + L_W$$

lb/a

lb/a

lb/a

i.

$$L_S = 365 K_E \left(\frac{\pi D^2}{4} \right) H_{VO} K_S W_T$$

lb/a

ft

ft³

lb/ft³

ii.

$$L_W = \frac{5.614}{RT_{LA}} M_V P_{VA} Q K_N K_P K_B$$

lb/a

lb/lb-mol

psia

bbbl/a

2.3-14

b.

VOCs

$$E_{\text{装卸}} = \frac{L_L \times V}{1000}$$

kg/m³

$$L_L = C_0 \times S$$

kg/m³

2.3-13

2.3-13

	kPa)			Btu/ft ² day	m ³	m	/	pa	pa	m	m	t/y	t	t/y	t/y
	101	36	12	1547	10.18	1.8		30kpa(G)		3.4	0.4	0.079	18	0.0113	0.09
	101	36	12	1235.7	2.49	1.2		1Mpa		1.8	1.2	0.0124	72	0.0466	0.059
	101	36	12	1232.53	7.9	1.6		1.1Mpa		3.4	2.5	0.03	14.4	0.0455	0.039

2.3-14

	P _T Pa	kg/m ³	g/mol			s	t/a	^N m ³ /a	t/a
	4080	780	64			0.6	18	23	0.00867
	160000	560	58			0.6	72	94	0.035
	1023000	510	42			0.6	14.4	19	0.0069

2

1

TBA

TBHP

TBA

6m

99%

VOCs(

TBA)

99.8%

2.3-15

2.3-15

			m ³ /h	mg/m ³	kg/h	t	kg/h	mg/m ³
1		VOCs	45000	20.14	0.202	0.145	3.0	60
			45000	0.7	0.0007	0.00504	/	50
			45000	0.7	0.0003	0.00216	/	50
			45000	0.91	0.0041	0.02952	/	1

2.3-19 VOCs

6

1

VOCs

6

2

2

GB31571-2015

GB37822-2019

a

+

b

.

VOCs

VOCs

TBHP/TBA

104.4t/a

0.05057t/a

6

DB37/2801.6-2018

1

VOCs

VOCs

VOCs

VOCs

1844

2.3-16

2.3-16

			t		t
1		VOCs	3.64264	99%	0.036
2		VOCs	0.23857	20%	0.191

3

2.3-17

2.3-17

		kg/h	t	
	VOCs	0.202	0.145	h=6m =1.5m
	VOCs	--	0.227	--

2.3-18

2.3-18

		t/a
1		5.712
2	SO ₂	-
3	NO _x	10.648
4		0.4416
5	SO ₂	-
6	NO _x	6.96
7	VOCs	3.416
8		-
9		-
10		3.088
11		3.176
12		

2.3.9.3

90% 47.25m³ 72m³
 119.25m³

2.3-19

2.3-19

			m ³				m ³	
-			52.5	COD			47.25	
				SS				
--			72	--			72	
			124.5	--	--	--	119.25	--

2.3-23

119.25m³

COD 1500mg/L

450mg/L

COD 0.0072t 0.00095t

2.3-20

2.3-20

		m ³ /h	(mg/L,PH)		m ³ /h	
		6.2	PH COD SS		6.2	
		2.26	COD SS		0	
		1.08	78%		0	
	H ₂	1.2	COD		0	
		20	COD	PO	20	
		30	COD	PO	30	
		39.5	PH		0	
		11	PH		0	
		45m ³ /	Na ₂ CO ₃ :10 30%		0	(7 8)
		13.85	PH COD		13.85	
PO		480	COD		480	
		2			2	
		6	COD		2	
		2.58	COD		2.58	
		4	COD		4	

		15.273	COD SS	-	15.265	
		33.95	COD	-	33.95	
		142.6	COD		0	
		609.583				

2.3.9.4

2.3-21

2.3-22

2.3-21

1	TBHP/TBA	HW49	900-047-49	41.09t			TBHP TBA	1		

2.3-22

			t/a			
1			8640	CaCO ₃ Mg(OH) ₂ NaCl		
			1m ³ /a			
			0.017			
2			CaO 17000	CaCl ₂ 40% SS 1% Ca(OH) ₂ 8% H ₂ O 50% Mg(OH) ₂ 1%		
			134	CaO CaCO ₃		
3			2.4	Fe		
			9623.31			
			40 8	Al ₂ O ₃		
			526.48		HW45	
			914.89		HW11	

			45.2		HW45	
			300		HW50	
			17.7		HW11	
			2068.42		HW11	
			3.5		HW08	
			6 3		HW49	
4			14		HW06	
			1 3		HW06	
			30		HW08	
			0.2			
			240			
5			33.68	-	-	
6			105	-	-	
7			6		HW49	
8			660t 20t			
9	PO/TBA	TBHP/TBA	41.09	TBHP TBA	HW49	

2.3.9.5

2.3-23

2.3-23

		dB A		
1		75~80	11	70~75
2		75~80	1	70~75
3	TBHP	75~80	1	70~75
4	TBHP	75~80	1	70~75
5		85~90	4	65~70
6		85~90	4	65~70
7		85~90	7	65~70
8		85~90	1	65~70
9		85~90	11	65~70
10		75~80	1	70~75
11		75~80	1	70~75
12		75~80	1	70~75
13		75~80	1	70~75

1

2

3

4

2.3-24

2.3-24

1	25 /		7	80
			8	95
			2	95
			3	95
2	12 / HCL		6	95
			4	75
			3	85
			6	90
			4	85
			6	80
			1	100
			26	75
			21	75
3	10 /		6	75
			1	90
			6	75
4			2	95
			2	95
			14	80
5			6	75
			1	90
			6	75
6	PO		6	70
			3	85
			2	84
7			2	80
			5	90
			2	80
8			6	85

9		11	80	60
10		1	80	60
11	TBHP	1	80	60
12	TBHP	1	80	60
13		4	90	70
14		4	90	70
15	PO/TBA	7	90	70
16		1	90	70
17		11	90	70
18		1	80	60
19		1	80	60
20		1	80	60
21		1	80	60



		t/a	0.84	0	0	0.84	0
		m ³ /a	4875280	0	119.25	4875399.25	119.25
	COD	t/a	292.52	0	0.0072	2929.5272	0.0072
		t/a	39	0	0.00095	39.00095	0.00095
		t/a	3928.49	0	41.09	3876.19	41.09
		t/a	35804.67	0	0	93696.06	0

2.4

2.4.1

1

2

3

4

1

2

3

4

5

6

7

8

2.4.2

39

2.4.3

1

2

3

3.1

3.1.1

527.86km²

62.91%

3462hm²

1872hm²

3.1.3

4

6

1

33.705km

355

km³

501.2

km³

311 km³

287 km³

156.1 km³

220 km³ 1997

19 km³ 2002

20 km³

41.89 km³

2

20.964km

6.693 km³

23.5 km³

0.397 km³

1459 km³

0.35 km³

3

2km

4

1965

72.5

1241.3km²

606.6km²

5

23.5km

1/8000

20m³/s

0.89km²

50

3

140m

3.1-2

3.1.4

2016 6

2015 1054

1



2	100			
3	100			
4	100			
5				100
		14.9km		2.7km
	20.1km,		5.6km,	
4km				
		3.1-3		
3.1.5				
		3.6g/L		
				300m



4m
300m
500 m³ 1400 m³
1000 m³
0.6 m³/d
3 m³/d 10 m³/d 2.3 m³/d

3.1.6

2.5m/s 5 28.5m/s
13.3 7 26.9
567mm 66.8% 66%
8 7 80% 77% 2325.7

1786.1mm

3.2

3.2.1

2005-2020 2005
2011 5

3.2.2

2011 10 9

[2011]65

2011 11 16

[2011]143

200m

6.02km²

3.06km²

2.96km²

2019 144

				3.2-2		3.2-3
3.3						
	1					
		2018		7		
				GB/T3095-2012		
		22 g/m ³		39 g/m ³		
		98 g/m ³	0.40		54 g/m ³	
0.54			1.8mg/m ³			209 g/m ³
0.31						
			6.05		11.4%	
	2					
		2018		11	16	2
			12.5%	5	31.3%	6
		3	18.8%			1.8
		16.4		18.5		4.5
				24		14
				23	10	
		43.5%				
				14		60.9%
	9		39.1%			
				13		56.5%
10			43.5%			
	3					
		2018		13		
	9					

9

4

3

3

13

12

4

7 ()

825

48.2 63.0dB A

48.2dB A

51.2 52.8 53.4 53.7dB

A

55.9dB A

63.0dB A

42.8 54.7dB A

42.8 44.0 44.1 44.3dB A

45.7 47.6dB A

54.7dB A

4

4.1

4.1.1

VOCs

1.6-1

4.1.2

HJ2.2-2018 5.3

4.1.2.1

HJ2.2-2018

AERSCREEN

HJ2.2-2018 C

4.1-1

4.1-1

/	/		3km
	/	40.7	20
	/	-16.4	
			3km
	/m	90	SRTM DEM UTM 90m
	/m	--	3km
	/°	--	

4.1.2.2

-

HJ2.2-2018

A

10%

$$P_i = \frac{C_i}{C_{0i}} \times 100\%$$

i

%

1h

g/m³

g/m³

AERSCREEN

4.1-2

4.1-2

		g/m ³	m	m	g/m ³	
	VOCs	210.1	12	0	1200	17.50
		0.1483	12	0	3000	0.0049
		0.9592	12	0	800	0.1199
	VOCs	168.7	19	0	1200	14.06
	VOCs	912.7	19	50	1200	76.05

VOCs =76.05% 10%

4.1.3

D10%

VOCs

50m

HJ2.2-2018

5.4

5km

4.1.4

2017

2017

4.1.5

4.1-3

4.1-3

	/m						m
	X	Y					
	-478	-490				SW	490
	-1285	1177				SW	1170
	-1676	516				SW	1540

1.5-1

4.2

4.2.1

2017 7 ,
 PM₁₀ 110 g/m³ GB3095-2012
 0.57 PM_{2.5} 64 g/m³ 0.83 SO₂
 32 g/m³ NO₂ 40 g/m³

2017 PM₁₀ 4.93 PM_{2.5} 9.2%
 GB3095-2012

4.2.2

W 2017

1 4.2-1

4.2-1

SO ₂	g/m ³			32	60	53.3%
		98%	357	350	86	150
NO ₂	g/m ³			42	40	105.0%
		98%	358	351	86	80

PM ₁₀	g/m ³			108	70	154.3%		
		95%	351	334	235	150	156.7%	
PM _{2.5}	g/m ³			71	35	202.9%		
		95%	349	332	165	75	220.0%	
CO	mg/m ³	95%	357	340	3	4	75.0%	
O ₃	g/m ³	90%	8h	356	321	187	160	116.9%

2017

SO₂ CO

24h

GB3095-2012

NO₂ PM₁₀ PM_{2.5} O₃

24h 8h

4.2.3

1

3

4.2.3.1

1

HJ2.2-2018

2

4.2-1

4.2-1

4.2-1

1#		WSW	/	
2#		W	NW 780m	

2

VOCs

3

4.2-2

4.2-2

1		GBZ/T160.58-2004	-	0.3mg/m ³

2				0.022mg/m ³
3		HJ 683-2014		0.47mg/m ³
4	VOCs	HJ 644-2013	- / -	0.3-1.0 g/m ³

4

2020 5 14 -20 7d 2:00 8:00 14:00 20:00

60min

5

4.2-3

4.2-4

4.2-3

		()	(hPa)	(m/s)		
2020.5.14	02:00	13.9	1009	1.3	SE	
	08:00	16.4	1009	1.0	SE	
	14:00	21.2	1009	0.9	SE	
	20:00	18.1	1009	0.9	SE	
2020.5.15	02:00	14.3	1007	0.9	NE	
	08:00	17.6	1007	0.7	NE	
	14:00	24.0	1007	0.5	NE	
	20:00	18.7	1007	0.7	NE	
2020.5.16	02:00	15.7	1002	0.7	SW	
	08:00	22.3	1002	0.5	SW	
	14:00	29.8	1002	0.4	SW	
	20:00	24.4	1002	0.6	SW	
2020.5.17	02:00	10.3	1007	0.9	NE	
	08:00	16.9	1007	0.8	NE	
	14:00	25.1	1007	0.8	NE	
	20:00	19.6	1007	0.7	NE	
2020.5.18	02:00	8.2	1006	1.2	NW	
	08:00	11.9	1006	1.0	NW	
	14:00	20.3	1006	0.9	NW	
	20:00	16.7	1006	0.9	NW	
2020.5.19	02:00	11.4	1005	1.1	NW	
	08:00	16.8	1005	1.0	NW	

	14:00	24.5	1005	0.7	NW	
	20:00	21.4	1005	0.8	NW	
2020.5.20	02:00	13.9	1007	1.0	S	
	08:00	19.6	1007	1.0	S	
	14:00	28.4	1007	0.8	S	
	20:00	25.1	1007	0.9	S	

4.2-4

		1#				2#			
		mg/m ³	mg/m ³	g/m ³	VOCs g/m ³	mg/m ³	mg/m ³	g/m ³	VOCs g/m ³
2020.5.14	02:00	ND	ND	ND	18.3	ND	ND	ND	15.6
	08:00	ND	ND	ND	86.3	ND	ND	ND	72.1
	14:00	ND	ND	ND	96.7	ND	ND	ND	106
	20:00	ND	ND	ND	115	ND	ND	ND	56.6
2020.5.15	02:00	ND	ND	ND	7.9	ND	ND	ND	20.6
	08:00	ND	ND	ND	52.7	ND	ND	ND	100
	14:00	ND	ND	ND	52.6	ND	ND	ND	130
	20:00	ND	ND	ND	93.4	ND	ND	ND	89.8
2020.5.16	02:00	ND	ND	ND	43.2	ND	ND	ND	10.1
	08:00	ND	ND	ND	76.6	ND	ND	ND	88.3
	14:00	ND	ND	ND	47.3	ND	ND	ND	64.0
	20:00	ND	ND	ND	53.1	ND	ND	ND	74.5
2020.5.17	02:00	ND	ND	ND	6.0	ND	ND	ND	4.2
	08:00	ND	ND	ND	26.7	ND	ND	ND	60.5
	14:00	ND	ND	ND	45.6	ND	ND	ND	55.9
	20:00	ND	ND	ND	40.6	ND	ND	ND	67.8
2020.5.18	02:00	ND	ND	ND	16.2	ND	ND	ND	15.7
	08:00	ND	ND	ND	75.0	ND	ND	ND	90.2

	14:00	ND	ND	ND	78.4	ND	ND	ND	58.2
	20:00	ND	ND	ND	64.8	ND	ND	ND	75.2
2020.5.19	02:00	ND	ND	ND	14.2	ND	ND	ND	19.2
	08:00	ND	ND	ND	84.0	ND	ND	ND	87.9
	14:00	ND	ND	ND	56.0	ND	ND	ND	88.0
	20:00	ND	ND	ND	34.8	ND	ND	ND	50.2
2020.5.20	02:00	ND	ND	ND	14.0	ND	ND	ND	35.3
	08:00	ND	ND	ND	44.7	ND	ND	ND	103
	14:00	ND	ND	ND	37.6	ND	ND	ND	108
	20:00	ND	ND	ND	79.4	ND	ND	ND	193

4.2.3.2

1

= —

mg/m³

mg/m³

1

1

2

VOCs

HJ2.2-2018

D

4.2-5

4.2-5

			1h	8h
1		g/m ³	3000	--
2		g/m ³	800	--
3	VOCs	g/m ³	1200 8	2 600

3

4.2-6

4.2-6

						%
1#			28	0 0.011	0	0
			28	0 0.235	0	0
	VOCs		28	0.005 0.0958	0	0
2#			28	0 0.011	0	0
			28	0 0.235	0	0
	VOCs		28	0.0035 0.1608	0	0

4.2-6

VOCs

4.3

4.3-4

4.3-5

4.3-1

4.3-3

4.3-2

4.3-6



3

62

25

9

22

0.1

153.33

516.15

8000

VOCs

0.004

4

Y

I

VW

AW

I

4.4

4.4.1

VOCs

4.4.2

5km

10%

4.4.3

2017

2017

1

4.4.4

5km

0.5m/s

72h 20

35%

3km

AERMOD

EIAProA-2018 Ver 2.6

4.4.5

4.4.5.1

AERMOD

2017

118°E 37°35 N

7.8km

50km

-

USGS

NCEP/NCAR

MM5

40°

110.0°

50 50

81km 81km

43 43

27km 27km

2017

08 20

3000m

19

50km

4.4.5.3

SRTM DEM

UTM 90m

DEM

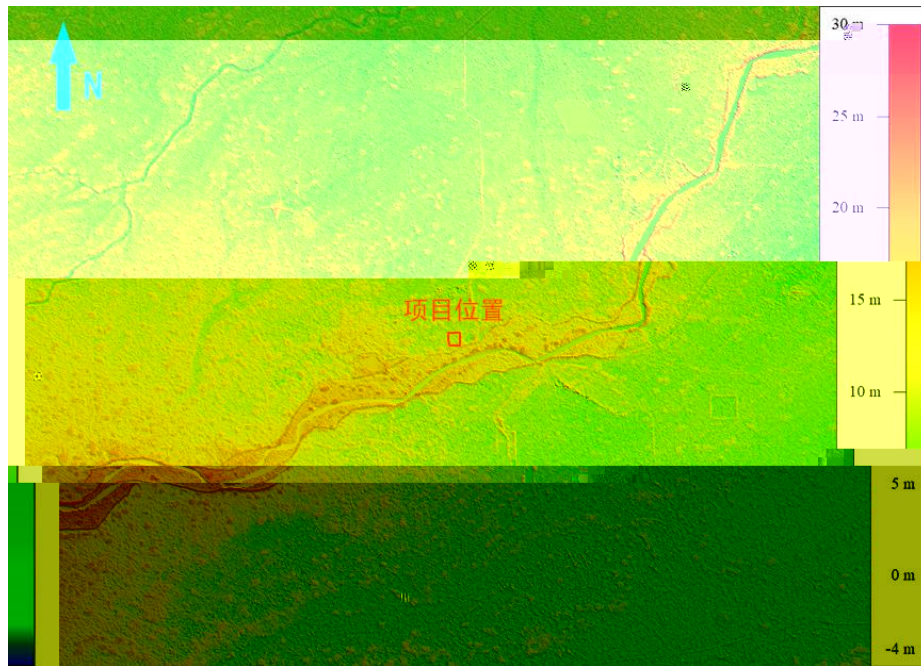

4.4-1

1:240000

4.4.5.4

1

AERSURFACE

4.4-8

				BOWEN	
	0-360	12 1 2	0.6	1.5	0.01
	0-360	3 4 5	0.14	0.3	0.03
	0-360	6 7 8	0.2	0.5	0.2
	0-360	9 10 11	0.18	0.7	0.05

4.4.6

AERMOD

SO₂ NO_x

4.4.7

1h

4.4-9

	-			
			1h	
	+ -			

4.4.8

4.4.8.1

4.4-10

4.4-10

				g/m ³	%	
VOCs		1	17081	11.3	0.94	
		1	17072006	10.75	0.90	
		1	17082721	9.4	0.82	
		1	17010215	104.12	8.68	

4.4.8.2

-

4.4-11

4.4-11

				g/m ³	%
VOCs		1	17062907	0.3	0.02
		1	17062907	0.11	0.01
		1	17061107	0.09	0.01
		1	17080407	18.75	1.56

4.4-13

VOCs

				g/m ³	%	
VOCs		1	17081206	61.409	5.12	
		1	17080407	41.057	3.42	
		1	17031918	44.426	3.7	
		1	17081307	336.878	28.07	

4.4.8.5

50m

366

4.4-14

4.4-14

				g/m ³	g/m ³	
1	VOCs	17041607	24 198	73.19	2000	

VOCs

6

DB37/2801.6-2018

3

4.4.9

PM₁₀ PM_{2.5}

VOCs

4.4.10

4.4.10.1

4.4-15

4.4-16

4.4-15

		VOCs	t/a	0.145	
			t/a	0.00504	

			t/a	0.00216
		VOCs	t/a	0145
		VOCs	t/a	0.145
			t/a	0.00504
			t/a	0.00216

4.4-16

					mg/m ³	t/a
1		VOCs	--	6 DB37/2801.6-2018	2.0	0.227

4.4-17

			t/a
1		VOCs	0.372

4.4.10.2

4.4-18

4.4-18

				kg/h	h		
1		VOCs	9.07	4	1		

4.5

4.5-1

4.5-2

4.5-1

	VOCs		6 DB37/2801.6-2018

4.5-2

--	--	--	--

	VOCs	1 /	DB37/2801.6-2018	6 3
--	------	-----	------------------	--------

4.5.2

4.5-3

4.5-3

	VOCs		HJ2.2-2018	D

4.6

4.6.1

2017

VOCs

VOCs

8.68%

100%

4.6.2

PM₁₀ PM_{2.5}

VOCs

4.6.3

VOCs

6

DB37/2801.6-2018 3

VOCs

4.6.4

VOCs

0.372t/a

VOCs

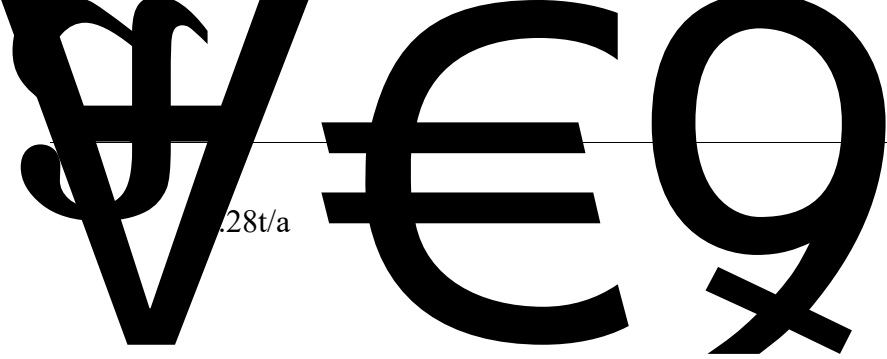

.28t/a

SO₂+NO

2000t/a

=50km

500~2000t/a

5 50km

500t/a

PM_{2.5}
PM_{2.5}

VOCs

D

2017

AERMOD ADMS AUSTAL2000 EDMS/AEDT CALPUFF

50km

5 50km

=5km

VOCs

PM_{2.5}
PM_{2.5}

~ 100%

100%

~ 10%

10%

~ 30%

30%

~ 100%

100%

1h

4 h

~ -20%

-20%

VOCs

VOCs

1

m

SO₂: t/a

NO_x: t/a

47.25m³/a

72m³/a

119.25m³/a

HJ2.3-2018 5.2 "

B"

B

HJ2.3-2018

B

500m

3000m

B

5.2

5.2.1

2018

5.2-1

2018

GB3838-2002

380m "

"

5.2-3

5.2-3

1	pH		GB/T6920-1986	/
2	COD _{Mn}		GB/T11892-1989	0.5mg/L
3			HJ535-2009	0.025mg/L
4			HJ636-2012	0.05mg/L
5			GB11893-89	0.01mg/L
6			GB/T11901-1989	4mg/L
7			HJ637-2012	0.01mg/L
8			GB/T16489-1996	0.005mg/L
9			GB7484-87	0.05mg/L
10			GB/T11896-1989	10mg/L
11			GB/T11899-1989	10mg/L
12			HJ/T51-1999	10mg/L
13			HJ755-2015	20MPN/L

5

5.2-4

5.2-5

5.2-4

				m	m	m/s	m ³ /s
1# 500m	2018.04.25		17.0	38.0	1.4	0.36	19.15
			18.1				
	2018.04.26		18.6				
			19.0				
2# 500m	2018.04.25		17.2	36.0	1.7	0.50	30.60
			17.7				
	2018.04.26		18.1				
			19.0				
3# 3000m	2018.04.25		16.3	36.0	1.6	0.53	30.53
			18.0				
	2018.04.26		18.5				
			18.6				

5.2-5

				1#	2#	3#
1	pH	2018.4.25		6.58	6.82	6.64
				6.73	6.79	6.75
		2018.4.26		6.63	6.81	6.59
				6.71	6.76	6.67
2	COD _{Mn} mg/L	2018.4.25		8.4	8.1	7.5
				8.5	8.0	7.4
		2018.4.26		8.3	9.2	8.5
				8.1	9.0	8.4
3	mg/L	2018.4.25		3.72	3.15	2.74
				3.52	2.64	2.80
		2018.4.26		3.07	1.87	2.57
				3.03	1.99	2.22
4	mg/L	2018.4.25		6.36	7.74	8.11
				6.17	7.87	8.69
		2018.4.26		5.52	7.90	9.12
				5.75	6.97	9.14
5	mg/L	2018.4.25		0.34	0.50	0.53
				0.33	0.52	0.52
		2018.4.26		0.36	0.52	0.48
				0.32	0.50	0.49
6	mg/L	2018.4.25		13	15	13
				13	10	15
		2018.4.26		15	13	16
				14	11	14
7	mg/L	2018.4.25		0.01	0.01	0.01
				0.01	0.01	0.01
		2018.4.26		0.01	0.01	0.01
				0.01	0.01	0.01
8	mg/L	2018.4.25		0.005	0.005	0.005
				0.005	0.005	0.005
		2018.4.26		0.005	0.005	0.005
				0.005	0.005	0.005

9	mg/L	2018.4.25		1.48	1.16	1.02
				1.48	1.20	1.06
		2018.4.26		1.42	1.16	1.06
				1.36	1.16	1.06
10	mg/L	2018.4.25		653	1.86 10 ³	1.94 10 ³
				650	1.86 10 ³	1.94 10 ³
		2018.4.26		705	2.05 10 ³	2.29 10 ³
				708	2.02 10 ³	2.28 10 ³
11	mg/L	2018.4.25		569	555	543
				548	568	544
		2018.4.26		519	571	556
				587	570	552
12		2018.4.25		2.10 10 ³	4.18 10 ³	4.23 10 ³
				2.13 10 ³	4.14 10 ³	4.14 10 ³
		2018.4.26		2.14 10 ³	4.36 10 ³	4.32 10 ³
				2.17 10 ³	4.31 10 ³	4.38 10 ³
13		2018.4.25		9.2 10 ³	5.4 10 ³	9.2 10 ³
				9.2 10 ³	3.5 10 ³	5.4 10 ³
		2018.4.26		5.4 10 ⁴	2.4 10 ⁴	1.6 10 ⁴
				3.5 10 ⁴	2.4 10 ⁴	1.6 10 ⁴

1

1.6-2

2

= —

pH

mg/L

mg/L

$$= \frac{7.0 -}{7.0 -} \quad (\quad -7.0)$$

$$= \frac{-7.0}{-7.0} \quad (\quad 7.0)$$

3

5.2-6

5.2-6

		1#	2#	3#
1	pH	0.27 0.42	0.18 0.24	0.25 0.41
2	COD _{Mn}	0.54 0.57	0.53 0.61	0.49 0.57
3		1.52 1.86	0.94 1.58	1.11 1.4
4		2.76 3.18	3.49 3.95	4.06 4.57
5		1.6 1.8	2.5 2.6	2.4 2.65
6		0.13 0.15	0.1 0.15	0.13 0.16
7		0.91 0.99	0.77 0.8	0.68 0.71
8		2.6 2.83	7.44 8.2	7.76 9.16
9		2.08 2.35	2.22 2.28	2.17 2.22
10		2.1 2.17	4.14 4.36	4.14 4.38
11		0.23 1.35	0.09 0.6	0.14 0.4

5.2-6

GB3838-2002

4 DB37/3416.4-2018 2

6 m²

2001 800m³/h 2012
2005 1100m³/h 2008
1100m³/h

+

~48000mg/L COD_{cr} 1500mg/L ~450mg/m³ pH 13
4

DB37/3416.4-2018 2

5.3-1

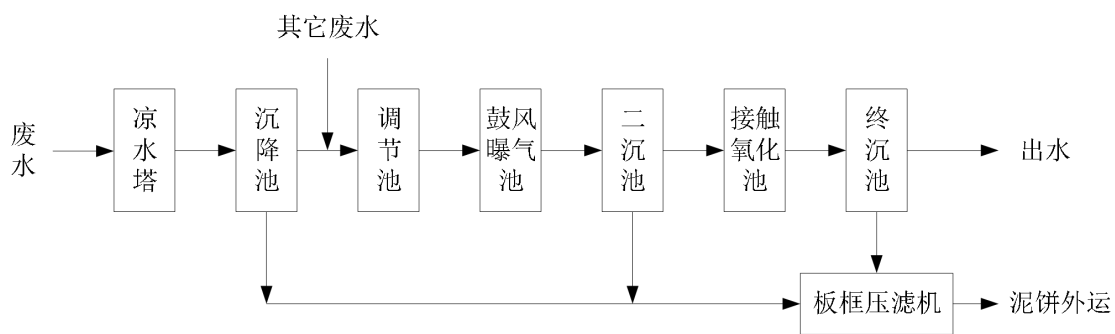

1460m³/h 1440m³/h

0.16m³/h

2018 1 -2018 6

5.3-1

5.3-1 2018 1 -6

	COD _{Cr}				NH ₃ -N			
	mg/L	mg/L			mg/L	mg/L		
2018 1	32.3~36.4	33.61	30	100%	0.49~5.83	2.58	30	100%
2018 2	27.9~58.9	36.61	31	100%	0.98~2.85	1.72	31	100%
2018 3	27.3~40.2	32.27	31	100%	0.34~1.11	0.62	31	100%
2018 4	27.8~47.6	33.86	30	100%	0.34~0.79	0.59	30	100%
2018 5	29.2~51	38.35	31	100%	0.36~1.54	0.66	31	100%
2018 6	28.9~47.3	37.34	30	100%	0.41~0.88	0.60	30	100%
DB37/675-2007	_60				_8			

5.3-1

4

DB37/3416.4-2018 2

119.25m³

COD 0.0072t

0.054t

COD 0.00024t

0.0000063t

5.4-1

5.4-1

1				3	
2		pH		3	
3		COD			

				3	
4				3	
5		BOD ₅		3	
6		SS		3	

5.4-2

5.4-2

1	500m 1000m 3000m	pH		3	
2		COD		3	
3				3	
4		BOD ₅		3	
5		SS		3	

5.5.2

5.5-1

5.5-1

1		COD SS				+	DW001		

2		--								
---	--	----	--	--	--	--	--	--	--	--

5.5-2

5.5-2

t

1 DW001 118 02 13.46 37 23 38.71 119.25

118°0 59.84 37°35

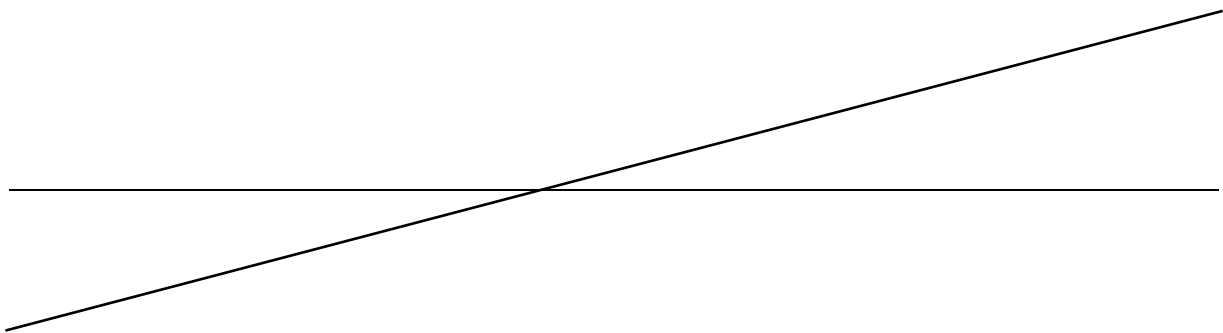

6

6.1

6.1.1

HJ610-2016

~~环境空气质量标准~~

HJ610 A

6.1-1

6.1-1

24

a

6.1-1

6.1-2

6.1-2

6.1.2

HJ610-2016

6.1-3

	km ²	
	20	
	6 20	
	6	

6.1-3

6km²

6.2

6.2.1

6.2.1.1

1

6

6.2-1

6.2-1

6.2-1

		m		
1#		800	S	
2#		770	NW	
3#		1360	NW	
4#		1330	S	
5#		1720	NW	
6#		2720	N	

2

K⁺ Na⁺ Ca²⁺ Mg²⁺ CO₃²⁻ HCO₃⁻ pH

1,2-

1,1 1-

1,1,2-

1,1-

1,2-

3

2019

8 28 11 25

4

6.2-2

6.2-2

1	pH	GB/T5750.4-2006		--
2		GB/T5750.4-2006		1.0mg/L
3		GB/T5750.4-2006		10mg/L
4		GB/T5750.7-2006		0.05mg/L
5		GB/T5750.5-2006		0.02mg/L
6		GB/T5750.5-2006		0.001mg/L
7		HJ84-2016		0.007mg/L
8				0.006mg/L

9				0.018mg/L
10				0.004mg/L
11		HJ700-2014		0.00009mg/L
12				0.00005mg/L
13	K ⁺	HJ776-2015		0.05mg/L
14	Na ⁺			0.12mg/L
15	Ca ²⁺			0.02mg/L
16	Mg ²⁺			0.003mg/L
17				0.004mg/L
18				0.01mg/L
19				0.006mg/L
20				0.004mg/L
21		HJ694-2014		0.00004mg/L
22				0.0003mg/L
23	CO ₃ ²⁻ HCO ₃ ⁻	DZ/T0064.49-1993		5mg/L
24		GB/T5750.5-2006	N,N-	0.005mg/L
25	1,1-	HJ810-2016	/ -	1.3 g/L
26	-1,2-			0.6 g/L
27	-1,2-			0.5 g/L
28	1,2-			0.5 g/L
29	1,1,1-			0.8 g/L
30				0.8 g/L
31	1,2-			0.8 g/L
32				0.8 g/L
33	1,1,2-			0.9 g/L
34				0.8 g/L
35		GB/T5750.4-2006		0.100mg/L
36		HJ503-2009		0.0003mg/L
37		GB/T5750.5-2006	-	0.002mg/L
38		GB/T5750.6-2006		0.004mg/L
39		GB/T5750.12-2006		1CFU/mL
40		GB/T5750.12-2006		2MPN/100 mL

6.2-3

6.2-4

6.2-3

		1#	2#	3#	4#	5#	6#
1	m	12.0	20.2	9.5	16.0	20.0	9.5
2	m	6.0	5.0	5.5	6.0	8.0	4.0
3		14.6	14.8	14.4	--	--	--
4							

6.2-4

			1#	2#	3#
1	pH	--	7.76	7.65	7.68
2		mg/L	1.03 10 ³	575	453
3		mg/L	1.77 10 ³	2.88 10 ³	1.47 10 ³
4		mg/L	0.192	0.494	0.523
5		mg/L	537	425	251
6		mg/L	123	529	253
7		mg/L	12.4	52.4	0.139
8	CO ₃ ²⁻	mg/L	ND	ND	ND
9	HCO ₃ ⁻	mg/L	662	1102	739
10		mg/L	0.027	0.800	ND
11		mg/L	0.10	0.24	0.07
12		mg/L	ND	ND	ND
13		mg/L	ND	ND	ND
14		mg/L	ND	ND	ND
15		mg/L	ND	ND	ND
16		mg/L	2.30	1.06	1.63
17		mg/L	ND	ND	ND
18		MPN/100mL	ND	14	ND
19		CFU/mL	18	130	2700
20		mg/L	ND	ND	ND
21		mg/L	ND	0.0005	0.0007
22		mg/L	ND	ND	ND
23		mg/L	ND	ND	ND
24		mg/L	0.04	0.01	0.03

25		mg/L	0.603	0.303	0.435
26		mg/L	ND	0.029	0.204
27		mg/L	ND	ND	ND
28	K ⁺	mg/L	2.87	24.7	1.02
29	Na ⁺	mg/L	214	756	365
30	Ca ²⁺	mg/L	161	81.5	77.9
31	Mg ²⁺	mg/L	156	108	68.8
32	1,1-	g/L	ND	ND	ND
33	-1,2-	g/L	ND	ND	ND
34	-1,2-	g/L	ND	ND	ND
35	1,1,1-	g/L	ND	ND	ND
36		g/L	ND	ND	ND
37	1,2-	g/L	ND	ND	ND
38		g/L	ND	ND	ND
39	1,1,2-	g/L	ND	ND	ND
40		g/L	ND	ND	ND

6.2.1.2

pH

1,1-

1,2-

1

GB/T14848-2017

1.6-3

2

3

6.2-5

6.2-5

		1#	2#	3#
1	pH	0.51	0.43	0.45
2		—	—	—
3		—	—	—

4		0.19	0.49	0.52
5		—	—	—
6		0.49	—	—
7		0.62	—	0.01
8		0.03	0.80	0.00
9		0.20	0.48	0.14
10		0.77	0.35	0.54
11		0.33	—	0.33
12		0.18	—	—
13		0.02	0.05	0.07
14		0.13	0.03	0.10
15		—	—	—
16		0.00	0.03	0.20
17		0.00	0.00	0.00

6.2-5

3

GB/T14848-2017

6.3

6.3.1

6.3.1.1

9

10

4

5

6.3.1.2

6.3m

6.3-1

6.3-2

6.3.2

1/7500

9.00-11.00m

60 250m

20g/L

250m

49.82-67.75m

1-2g/L

4.0-4kg/L

2m

6.3-3

6.3.3

1

0.40 1.70m

0.75m

0.90 2.50m

1.44m

7.20 8.91m

8.36m

2

$k=4.43 \cdot 10^{-6}$ $1.46 \cdot 10^{-5}$ cm/s

$k=1.00 \cdot 10^{-5}$ cm/s

400m

6km²

HJ 610-2016

100d 1000d 7200d

COD

1200mg/L

450mg/L,

20m_x 0.5m_x 4

COD

GB/T14848-2017

HJ 610-2016

$$C(x, y, t) = \frac{M}{4\pi \sqrt{\frac{u^2 t}{D_L} + \frac{y^2}{D_T}}} \exp\left[-\frac{u^2 t}{4D_L} - \frac{y^2}{4D_T}\right]$$

x — y —

t — d

$C(x, y, t)$ — t x y mg/L

M — m

m_M — M g

u — m/d

n —

D_L — m²/d

D_T — y m²/d

—

m_M M n

u D_L D_T

1 m_M

12m² 5

‰ 0.00864m/d

COD 1200mg/L 40m² 5‰ 0.00864m/d=0.0021kg/d

450mg/L 40m² 5‰ 0.00864m/d=0.00077kg/d

60d

6.4-1

		$CO_{D_{th}}$	
1	mg/L	3	0.5
2	mg/L	1200	450
3	kg/d	0.0021	0.00077
4	kg	0.126	0.0462

60d COD

2 M

-

5~20m

9.68m

~~149.68m~~

3 n

10m/d l 1.3

0.74 $e=n_e/1-n_e$ n_e 0.43

4 u

$V=Kl=0.013m^3/d$

$u=V/n=0.03m^3/d$

5 D

10.0m

$D_L = \alpha \times u = 10.0m \times 0.03m^3/d = 0.3m^3/d$

$D_r = 0.1D_L$ D_r 0.03m³/d

1 COD

		100d	COD _{Cr}	0.253mg/L	
1000d	COD _{Cr}	0.0253mg/L	7200d	COD _{Cr}	0.00352mg/L

GB/T14848-2017

COD_{Cr} 6.4-1

1

		100d	0.0931mg/L	
1000d		0.00931mg/L	7200d	0.00129mg/L

100d

GB/T14848-2017

1000d 7200d

GB/T14848-2017

6.4-2

1

7200d

2

7200d COD

320m

330m

4

7200d

COD

350m

6.5.2

GB/T50934-2013

GB/T50934-2013

COD

6.5-1

6.5-1

6.5-1

		15cm	15cm 5mm 7mm	6.0m
		15cm	15cm 5mm 7mm	1.0 10 ⁻⁷ cm/s

6.5.3

5

6.5-2

6.5-2

6.5-2

1	1	37.377°N 118.056°E	15m	PVC PVC	

2	2	37.377°N 118.06°E			
3	1	37.379°N 118.063°E			
4	2	37.383°N 118.057°E			
5	3	37.383°N 118.063°E			

6.5-3

6.5-3

pH					
1,1,1-	1,1,2-	1,1-	1,2- 1,2-	1 /	1 /

1 /

7.1

HJ2.4-2009 5.2
GB3096 3

HJ2.4-2009 6.1
200m 3
200m

7.2

7.2.1

7.2.1.1

11 7.2-1 7.2-1

7.2-1

1#	1m	
2#	1m	
3#	1m	
4#	1m	
5#	1m	
6#	1m	
7#	1m	
8#	1m	
9#	1m	
10#	1m	
11#		

7.2.1.2

2019 8 26 8 27

7.2.1.3

7.2-2

7.2-2a 2019 8 26

	dB A				dB A			
	10	50	90	eq	10	50	90	eq
1#	71.4	65.2	63.2	67.5	64.4	63.8	63.2	64.0
2#	68.8	62.8	58.6	65.3	61.0	58.6	58.0	59.6
3#	70.8	68.2	59.4	68.3	59.2	49.0	46.8	56.6
4#	67.6	58.8	52.8	63.5	61.2	55.0	54.	60.5
5#	74.6	73.2	72.2	73.6	56.0	52.6	52.0	55.6
6#	65.0	58.2	54.2	62.0	52.0	47.0	46.2	51.5
7#	63.8	54.4	52.0	60.3	53.6	52.4	51.8	53.5
8#	62.8	57.4	51.8	59.9	55.4	53.6	52.6	54.8
9#	70.2	64.4	58.6	66.5	60.8	51.8	49.2	56.5
10#	63.4	56.8	52.4	60.2	60.2	55.6	51.6	57.2
11#				48.1				46.2
/20min								
1#	44	10	178	36	2	126		
2#	40	6	165	32	0	88		
3#	50	8	182	28	4	80		
4#	35	2	174	34	2	82		
5#	12	0	45	8	0	24		
6#	10	2	41	6	0	28		
7#	13	4	34	8	2	25		
8#	36	8	154	17	4	45		
9#	42	10	152	21	2	52		
10#	30	2	140	24	0	58		

7.2-2b 2019 8 27

	dB A				dB A			
	10	50	90	eq	10	50	90	eq
1#	71.0	65.0	63.0	67.2	65.2	64.4	64.0	64.7
2#	66.4	62.8	58.8	64.0	61.4	59.0	58.4	59.9
3#	70.6	67.8	58.8	68.1	61.8	50.4	46.6	59.6
4#	67.6	58.6	52.4	63.4	62.4	52.4	51.6	61.6
5#	74.0	72.8	71.8	73.0	59.6	52.4	51.6	57.5
6#	64.6	57.6	54.0	61.9	50.0	47.4	46.4	48.4
7#	63.4	53.8	51.2	59.9	54.0	52.4	51.8	53.5
8#	62.2	56.8	51.4	59.0	55.6	53.8	53.6	54.0
9#	70.2	64.4	58.2	66.4	60.4	51.4	49	56.1
10#	64.6	59.4	53.6	61.3	59.8	54.4	51.6	56.6
11#				46.6				44.7
/20min								
1#	46	6	186	35	2	105		
2#	42	8	170	30	2	78		
3#	53	4	177	32	4	86		
4#	38	0	168	38	0	96		
5#	16	2	44	7	2	26		
6#	12	10	38	0	4	18		
7#	14	0	48	6	8	22		
8#	34	4	148	15	6	46		
9#	45	4	123	24	0	51		
10#	28	4	157	18	4	56		

7.2.2

7.2.2.1

dB A

A dB A

dB A

7.2.2.2

GB12348-2008

3

A

65dB

A

55dB

A

7.2.2.3

7.2-3

	dB A				dB A			
2019 8 26								
1#	67.5	65	2.5		64.0	55	9	
2#	65.3	65	0.3		59.6	55	4.6	
3#	68.3	65	3.3		56.6	55	1.6	
4#	63.5	65	-1.5		60.5	55	5.5	
5#	73.6	65	8.6		55.6	55	0.6	
6#	62.0	65	-3		51.5	55	-3.5	
7#	60.3	65	-4.7		53.5	55	-1.5	
8#	59.9	65	-5.1		54.8	55	-0.2	
9#	66.5	65	1.5		56.5	55	1.5	
10#	60.2	65	-4.8		57.2	55	2.2	
11#	48.1	65	-16.9		46.2	55	-8.8	
2019 8 27								
1#	67.2	65	2.2		64.7	55	9.7	
2#	64.0	65	-1		59.9	55	4.9	
3#	68.1	65	3.1		59.6	55	4.6	
4#	63.4	65	-1.6		61.6	55	6.6	
5#	73.0	65	8		57.5	55	2.5	
6#	61.9	65	-3.1		48.4	55	-6.6	
7#	59.9	65	-5.1		53.5	55	-1.5	
8#	59.0	65	-6		54.0	55	-1	
9#	66.4	65	1.4		56.1	55	1.1	
10#	61.3	65	-3.7		56.6	55	1.6	
11#	46.6	65	-18.4		44.7	55	-10.3	

7.2-3

1# 2# 3# 5# 9#

1# 2# 3# 4# 5# 9# 10#

1# 2# 3# 5# 9#

1# 2# 3# 4# 5# 9# 10#

7.3

7.3.1

7.3-1

7.3-1

		lm dB A	m			
1		70~75	445	285	215	443
2		70~75	440	300	218	438
3	TBHP	70~75	432	302	220	426
4	TBHP	70~75	428	305	225	423
5		65~70	438	302	227	426
6		65~70	443	290	222	438
7		65~70	440	278	225	450
8		65~70	428	292	237	416
9		65~70	444	283	221	445
10		70~75	445	300	220	428
11		70~75	443	290	222	438
12		70~75	405	285	260	443
13		70~75	420	275	240	453

7.3.2

7.3.2.1

1

A

A

$$() = \quad - \quad - \quad 1$$

$$() = () - \quad 2$$

$$= + + + +$$

3

() () A dB

(₀) () A dB

() A dB

dB

4π ()

)

(

M

()

$$= {}_2() + 10\lg \quad 5$$

3

()

$$() = 10\lg \left[\frac{1}{s} \left(\sum_{=1} 10^{0.1} + \sum_{=1} 10^{0.1} \right) \right] \quad 6$$

s

s

s

4

7

$$= 10\lg(10^{0.1} + 10^{0.1}) \quad 7$$

$$10/3 < r < 10 \quad 10/3 < r_0 < 10 \quad = 15 \lg r/r_0$$

2

3

$$= \lg \frac{r - r_0}{100}$$

a

4

7.3.3

7.3-2

7.3-2

	dB A			dB A		
	32.09	--	32.09	32.09	--	32.09
	35.51	73.6	73.6	35.51	57.5	57.5
	37.72	68.3	68.3	37.72	64.7	64.7
	32.03	66.4	66.4	32.03	57.2	57.2

7.3-2

GB12348-2008 3

7.4

1

2

3

4

TBHP/TBA

TBHP/TBA HW49	TBHP/TBA 41.09t	

TBHP/TBA

TBHP/TBA		HW49	900-047-49		3.59m ³	3m ²		3.59t		1

1

2

15cm

5mm

7mm

3

GB15562.2-1995

6

3

GB/T50934-2013

GB18597 HJ2025

HJ2025-2012

- TBHP/TBA

HJ964-2018

1

"

"

"

"

"

"

HJ964

A.1"

"

2

458.3m²

3

9.1-1

4

9.1-2

9.1-2

									--
								--	--
-									

9.1.2

HJ964-2018

7.2.2

9.1-3

9.1-3

		a	
		b	
			5km
			1km
			2km
			0.2km
			1km
			0.05km
a			
b			

9.1-3

200m

1

2

9.2-1 9.2-1

9.2-1

1#				0~0.5m	0.5~1.5m	1.5~3m
2#				0~0.2m		
3#				0~0.5m	0.5~1.5m	1.5~3m
4#		PO/TBA		0~0.5m	0.5~1.5m	1.5~3m
5#		0.2km		0~0.2m		
6#		0.2km		0~0.2m		

9.2.1.2

1~4#

pH

1,1-

1,2-

1,1-

-1,2-

-1,2-

1,2-

1,1,1,2-

1,1,2,2-

1,1,1-

1,1,2-

1,2,3-

1,2-

1,4-

+

2-

[a]

[a]

[b]

[k]

[a,h]

[1,2,3-cd]

5#

6#

pH

9.2.1.3

2019 8 27

2020 5 14

9.2.1.4

9.2-2

9.2-2

1	pH	NY/T1377-2007		--

2		HJ680-2013	/	0.01mg/kg
3				0.002mg/kg
4		GB/T17141-1997		0.01mg/kg
5				0.1mg/kg
6		LY/T1243-1999		0.5cmol()/kg
7		HJ736-2015	/ -	0.0030mg/kg
8		HJ834-2017	-	0.09mg/kg
9				0.01mg/kg
10	2			0.06mg/kg
11	[a]			0.1mg/kg
12	[a]			0.1mg/kg
13	[b]			0.2mg/kg
14	[k]			0.1mg/kg
15				0.1mg/kg
16	[a,h]			0.1mg/kg
17	[1,2,3 cd]			0.1mg/kg
18				0.09mg/kg
19		HJ642-2013	/ -	0.0015mg/kg
20				0.0021mg/kg
21	1,1			0.0016mg/kg
22	1,2			0.0013mg/kg
23	1,1			0.0008mg/kg
24	1,2			0.0009mg/kg
25	1,2			0.0009mg/kg
26				0.0026mg/kg
27	1,2			0.0019mg/kg
28	1,1,1,2			0.0010mg/kg
29	1,1,2,2			0.0010mg/kg
30				0.0008mg/kg
31	1,1,1			0.0011mg/kg
32	1,1,2			0.0014mg/kg
33				0.0009mg/kg
34	1,2,3			0.0010mg/kg

35				0.0015mg/kg
36				0.0016mg/kg
37				0.0011mg/kg
38	1,2			0.0010mg/kg
39	1,4			0.0012mg/kg
40				0.0012mg/kg
41				0.0016mg/kg
42				0.0020mg/kg
43	- + -			0.0036mg/kg
44	-			0.0013mg/kg
45		METHOD 3060A	ALKALINE DIGESTION FOR HEXAVALENT CHROMIUM	0.4mg/kg
46		HJ 491-2019		1mg/kg
47				3mg/kg

9.2-3

9.2-3a 1# 2# 3#

			1#			2#	3#		
			0~50cm	50~150cm	150~300cm	0~20cm	0~50cm	50~150cm	150~300cm
1		mg/kg	0.015	0.021	0.014	0.007	0.027	0.024	0.020
2		mg/kg	9.77	8.72	8.32	6.07	10.5	10.4	9.26
3		mg/kg	17.1	17.3	14.9	15.5	19.3	20.1	17.8
4		mg/kg	0.11	0.12	0.11	0.08	0.15	0.13	0.12
5		mg/kg	ND	ND	ND	ND	ND	ND	ND
6		mg/kg	ND	ND	ND	ND	ND	ND	ND
7		mg/kg	ND	ND	ND	ND	ND	ND	ND
8	1,1	mg/kg	ND	ND	ND	ND	ND	ND	ND
9	1,2	mg/kg	ND	ND	ND	ND	ND	ND	ND
10	1,1	mg/kg	ND	ND	ND	ND	ND	ND	ND
11	1,2	mg/kg	ND	ND	ND	ND	ND	ND	ND

12	1,2	mg/kg	ND	ND	ND	ND	ND	ND	ND
13		mg/kg	ND	ND	ND	ND	ND	ND	ND
14	1,2	mg/kg	ND	ND	ND	ND	ND	ND	ND
15	1,1,1,2	mg/kg	ND	ND	ND	ND	ND	ND	ND
16	1,1,2,2	mg/kg	ND	ND	ND	ND	ND	ND	ND
17		mg/kg	ND	ND	ND	ND	ND	ND	ND
18	1,1,1	mg/kg	ND	ND	ND	ND	ND	ND	ND
19	1,1,2	mg/kg	ND	ND	ND	ND	ND	ND	ND
20		mg/kg	ND	ND	ND	ND	ND	ND	ND
21	1,2,3	mg/kg	ND	ND	ND	ND	ND	ND	ND
22		mg/kg	ND	ND	ND	ND	ND	ND	ND
23		mg/kg	ND	ND	ND	ND	ND	ND	ND
24		mg/kg	ND	ND	ND	ND	ND	ND	ND
25	1,2	mg/kg	ND	ND	ND	ND	ND	ND	ND
26	1,4	mg/kg	ND	ND	ND	ND	ND	ND	ND
27		mg/kg	ND	ND	ND	ND	ND	ND	ND
28		mg/kg	ND	ND	ND	ND	ND	ND	ND
29		mg/kg	ND	ND	ND	ND	ND	ND	ND
30	⁺	mg/kg	ND	ND	ND	ND	ND	ND	ND
31		mg/kg	ND	ND	ND	ND	ND	ND	ND
32		mg/kg	ND	ND	ND	ND	ND	ND	ND
33		mg/kg	ND	ND	ND	ND	ND	ND	ND
34	2	mg/kg	ND	ND	ND	ND	ND	ND	ND
35	[a]	mg/kg	ND	ND					

38	[k]	mg/kg	ND	ND	ND	ND	ND	ND	ND
39		mg/kg	ND	ND	ND	ND	ND	ND	ND
40	[a,h]	mg/kg	ND	ND	ND	ND	ND	ND	ND
41	[1,2,3 cd]	mg/kg	ND	ND	ND	ND	ND	ND	ND
42		mg/kg	ND	ND	ND	ND	ND	ND	ND
43		mg/kg	ND	ND	ND	ND	ND	ND	ND
44		mg/kg	27	25	22	17	29	28	27
45		mg/kg	21	21	16	13	23	22	21

9.2-3b 4# 5# 6#

			4#			5#	6#
			0~50cm	50~150cm	150~300cm	0~20cm	0~20cm
1		mg/kg	0.161	0.0809	0.211	0.119	0.0975
2		mg/kg	14.4	17.2	12	6.5	9.1
3		mg/kg	33	34	30	28	34
4		mg/kg	28.7	23.4	14	13.8	4.0
5		mg/kg	ND	ND	ND	/	/
6		mg/kg	ND	ND	ND	/	/
7		mg/kg	ND	ND	ND	/	/
8	1,1	mg/kg	ND	ND	ND	/	/
9	1,2	mg/kg	ND	ND	ND	/	/
10	1,1	mg/kg	ND	ND	ND	/	/
11	1,2	mg/kg	ND	ND	ND	/	/
12	1,2	mg/kg	ND	ND	ND	/	/
13		mg/kg	ND	ND	ND	/	/
14	1,2	mg/kg	ND	ND	ND	/	/
15	1,1,1,2	mg/kg	ND	ND	ND	/	/

16	1,1,2,2	mg/kg	ND	ND	ND	/	/
17		mg/kg	ND	ND	ND	/	/
18	1,1,1	mg/kg	ND	ND	ND	/	/
19	1,1,2	mg/kg	ND	ND	ND	/D	/
20		mg/kg	ND	ND	ND	/	/
21	1						

46		mg/kg					
47		mg/kg	/	/	/	41	49
48		mg/kg	/	/	/	94	87

1.6-5 1.6-6

= $\frac{\quad}{0}$

9.2.2.4

9.2-4

9.2-4

	0~50cm	0.0004	0.16	0.021	0.002	0.03	0.0012	/	/
1#	50~150cm	0.0006	0.15	0.022	0.002	0.028	0.0012	/	/
	150~300cm	0.0004	0.14	0.019	0.002	0.024	0.0009	/	/
2#	0~20cm	0.0002	0.10	0.019	0.001	0.019	0.0007	/	/
	0~50cm	0.0007	0.18	0.024	0.002	0.032	0.0013	/	/
3#	50~150cm	0.0006	0.17	0.025					

6#	0~20cm	0.028	0.364	0.2	6.67	0.013	0.20	0.313	0.29
----	--------	-------	-------	-----	------	-------	------	-------	------

9.2-4 1# 2# 3# 4#

GB36600-2018 1

5# 6#

GB15618-2018 1

3.1

9.3-1

3.2-1

9.3-3

944464.62hm²

2011 10 31

123343.75hm²

7742.43hm²

15289.27hm²

172942.95hm²

60984.5hm²

35617.36hm²

6978.27hm²

16131.6hm²

10241.22hm²

41990.56hm²

9.3-1

9.3-1a

			15:58
		118.06665°	37.37815°
		0-20cm	

		<20
	cmol/kg	6.5
	(mv)	391.6
	(mm/min)	0.092
	(kg/m ³)	1.41
	(%)	50.2

9.3-1b

			11:32
	118.06151°		37.38304°
		0-20cm	
		<20	
	cmol/kg	7.2	
	(mv)	401.3	
	(mm/min)	0.113	
	(kg/m ³)	1.44	
	(%)	47.2	

200m

VOCs

HJ964-2018

GB36600-2018

4500mg/kg

HJ964-2018 8.7.3

E

9.4-1

4#		0~50cm	ND	4500
		50~150cm	ND	
		150~300cm	ND	

GB36600-2018

" "

6.5.2

9.5.3

9.5-2

1		pH	1,1-		
		1,2-	1,1-	-1,2-	
			-1,2-	1,1,1,2-	1 /
			1,1,2,2-		
2		1,1,1-	1,1,2-		GB36600-2018

1# 2# 3# 4#

GB36600-2018 1

5# 6#

GB15618-2018 1

GB36600-2018

	a	b	c	d		
	9.3-1					C
			1	2	0~0.2m	
			3	--	0~0.5m 0.5~1.5m 1.5~3m	
	1~4#	pH				
					1,1-	
	1,2-	1,1-		-1,2-		-1,2-
		1,2-		1 1 1 2-		1,1,2,2-
			1,1,1-		1,1,2-	
	1,2,3-				1,2-	1,4-
					+	
			2-	[a]	[a]	[b]
		[k]		[a,h]	[1,2,3-cd]	
	5# 6#	pH				
	GB 15618	GB 36600	D.1	D.2		
		E	F			
		a	b	c		
		a	b			
		2		9.5-2	1 /1	
1						
2						

10

10.1

			25 /	
20 /		12 /	VCM	
			HCL	15 /
	6 /		3 /	
8 /	2 /			8 /
		2 /		2000 /
				2 2 -
				(
)

(1)

(2)

(GB50016-2006)

(3)

16 140
5kg 8kg 35kg 3kg 8kg CO₂

(4)

(5)

(6)

(7)

(8)

(9)

10.2

10.2.1

			/	
1			t	
2			72	
3	TBHP		/	
4			15.12	
5			/	
6			/	
7			/	

	2.1				
	LD50 800mg/kg LC501900mg/kg				
		UN	1969	CAS NO.	75-28-5
	21012		O52		
				15	15
	:				/

10.2-3

				tert-butyl alcohol trimethyl carbinol		
	C ₄ H ₁₀ O		74.12	470		11
	25.3		82.8	5.33kPa/24.5		
	=1	0.79	(kJ/mol)	2630.5		
	=1	2.55		-		
(vol%)	2.3-8.0%					
	3.2					
	LD ₅₀ 03500mg/kg() LC ₅₀					
		UN	1120	CAS NO.	75-65-0	
	32066		O52			

	()

10.2-4

	C ₃ H ₆ CH ₃ CHCH ₂		
	42.08		602.88kPa/0 -108
	-191.2 -47.7		
	(=1)0.5 (=1)1.48		
	15% 30	35 40% 20	260mg/L 4
		35% 20	
	()		21018
	4()		
		()	

10.2-5

	1 2-		1,2-epoxypropane propylene oxide

	C ₃ H ₆ O CH ₃ CHOCH ₂		58.08		-		-37
	-104.4		33.9		75.86kPa/25		
	=1		0.83	(kJ/mol)	-		
	=1		2.0		-		
(vol%)	2.1-37%						
	7()						
	LD ₅₀ 1140mg/kg() 1245mg/kg() LC ₅₀ 4127mg/m ³ 4 ()						
			UN	1280	CAS NO.	75-56-9	
	31032						
	15 15						
	()						

10.2-6

	2-			2-methyl propionic acid			
	C ₄ H ₈ O ₂		88.11		481		55
	-47		154.5		0.13kPa(14.7)		
	=1		0.95	(kJ/mol)	2165.3		
	=1		3.04		336		
(vol%)	2.0-9.2%						

	3.2				
	LD ₅₀ 400-800 mg/kg() LC ₅₀				
		UN	2529	CAS NO.	79-31-2
	33592		O53		-
					()

10.2-7

				methyl alcohol		
	CH ₄ O		32.04		385	11
	-97.8		64.8		13.33kPa(21.2)	
	=1		0.79	(kJ/mol)	727.0	
	=1		1.11		240	
(vol%)		5.5%	44.0%			
	3.2					
	LD ₅₀ 5628 mg/kg() 15800 mg/kg() LC ₅₀ 83776mg/m ³ 4 ()					
				UN	1230	CAS NO. 67-56-1
		32058				7

	()
	1
	()

10.2-8

				acetone		
	C ₃ H ₆ O		58.08		465	-20
	-94.6		56.5		53.32kPa(39.5)	
	=1	0.80		(kJ/mol)	1788.7	
	=1	2.00			235.5	
(vol%)	2.5% 13.0%					
	3.2					
	LD ₅₀ 5800 mg/kg() 20000 mg/kg() LC ₅₀ ()					
			UN	249	CAS NO.	67-64-1
	31025					7

10.3-1

10.3-1 Q

	CAS	/t	Q _n /t	Q
1	75-28-5	1.064	10	0.1064
2	75-56-9	0.051	10	0.0051
3	115-07-1	3.5	10	0.323
4	67-56-1	0.004	10	0.0004
5	67-64-1	0.072	10	0.0072
				0.4421

TBHP GB30000.18 1 2 3 GB30000.28
 1 Q
 10.3-1 1

10.3.2

10.3-2

10.3-2

	+			
				a
a				

10.3-1 10.3-2

10.4

10.4.1

2015

2015 80

10.4-1

10.4-1

CAS			
75-28-5			1

1

/

2

75-56-9

10.4-3

			/		
			/		

10.5

HJ169-2018 A

10.5.1



10.6.2.2

GB50483-2009

=

$$\begin{aligned} & - & - \\ & = & 1^+ \quad 2^+ \quad \text{max}^- \quad 3 \\ & 1^+ \quad 2^+ \quad \text{max} & m^3 \\ & 1 & m^3 \\ & 2 & \\ & & 3 \quad m^3 \\ & & m^3 \\ & 3 & \\ & m^3 & \end{aligned}$$

10.6-1

10.6-1

1		2m ³ =2m ³	2	24.37m ³ =24.37m ³	24.37
2		2018 8.43 150L/s 3h =3 3600 150 10 ⁻³ =1620m ³	1620	GB50160-2008 6.0L/ min m ² 13.72m ² 2=4 60 13.72 6.0 10 ⁻³ =19.76m ³	19.76
3		P=3 t=3h q=57.58L/s hm ² =0.95 0.08ha =57.58 0.95 0.08 3 3600 10 ⁻³ =47.26m ³	47.26	P=3 t=3h q=57.58L/s hm ² =0.95 0.009ha =57.58 0.95 0.009 3 3600 10 ⁻³ =5.3m ³	5.3
4		=0	0		0
5		= 1+ 2+ - 3	1669.26	= 1+ 2+ - 3	49.43

10.7-1 1718.69m³
5400m³

10.6.3

1

2

GB/T50934-2013

6.0m

1.0 10⁻⁷cm/s

3

5

10.6.4

10.6-3

10.6-3

1	300m	VOCs	15min/
2	200m		1h/

10.6-4

10.6-4

4	3M	6
2		
2m ³		2
1		

10.7

10.7-1

PO/TBA	
TBHP	

		/t	1.064	0.051	3.5	0.072	0.004
			500m	0	5km		
			200m				
				F1	F2	F3	
				S1	S2	S3	
				G1	G2	G3	
				D1	D2	D3	
		Q	Q 1	1_Q 10	10_Q 100	Q 100	
		M	M1	M2	M3	M4	
		P	P1	P2	P3	P4	
			E1	E2	E3		
			E1	E2	E3		
			E1	E2	E3		
		+					
					/		
			SLAB	AFTOX			
				-1	<u>m</u>		
				-2	<u>m</u>		
				--	--h		
					<u>d</u>		
					--d		

(8)

(9) 5400m³

10.2

10.2.1

2015

10.2-1

10.2-1

					/ t	/ t	
1			99.9%		1.064	72	
2			99.9%		13.65	/	
3	TBHP				2.76	/	
4			99.6%		3.23	15.12	
5					0.051	/	
6			99%		0.004	/	
7					0.072	/	

MSDS

10.2-2 10.2-8

10.2-2

	2-				Isobutane 2-Methylpropane		
	C ₄ H ₁₀		58.12		460		-82.8
	-159.64		-11.8		160.09kPa/0		
	=1		0.56	(kJ/mol)	2856.6		
	=1		2.01		135		
(vol%)	1.8-8.5%						
	2.1						

	LD50 800mg/kg LC501900mg/kg				
		UN	1969	CAS NO.	75-28-5
	21012		O52		
				15	15
	:				/

10.2-3

				tert-butyl alcohol trimethyl carbinol		
	C ₄ H ₁₀ O		74.12		470	11
	25.3		82.8		5.33kPa/24.5	
	=1		0.79	(kJ/mol)	2630.5	
	=1		2.55		-	
(vol%)	2.3-8.0%					
	3.2					
	LD ₅₀ 3500mg/kg()					
	LC ₅₀			UN	1120	CAS NO. 75-65-0
	32066				O52	

	()

10.2-4

	C ₃ H ₆ CH ₃ CHCH ₂			
	42.08			602.88kPa/0 -108
	-191.2			
	-47.7			
	(=1)0.5			
	(=1)1.48			
	15%	30	35 40% 20	260mg/L 4
			35% 20	
	()			21018
	4()			
			()	

10.2-5

1 2-

1,2-epoxypropane propyle

4

	3.2				
	LD ₅₀ 400-800 mg/kg() LC ₅₀				
		UN	2529	CAS NO.	79-31-2
	33592		O53		-
					()

10.2-7

				methyl alcohol		
	CH ₄ O		32.04		385	11
	-97.8		64.8		13.33kPa(21.2)	
	=1		0.79	(kJ/mol)	727.0	
	=1		1.11		240	
(vol%)	5.5% 44.0%					
	3.2					
	LD ₅₀ 5628 mg/kg() 15800 mg/kg() LC ₅₀ 83776mg/m ³ 4 ()					
		UN	1230	CAS NO.	67-56-1	
	32058				7	

	()

10.2.2

1.5-2 1.5-1

10.3

10.3.1

P

1

Q

HJ169 B

$$Q = \frac{q_1}{Q_1} + \frac{q_2}{Q_2} + \dots + \frac{q_n}{Q_n}$$

1 2

t

1 2

t

1

1

1 1、

10

2 10、

100

3

100

10.3-1

10.3-1 Q

	CAS	/t	Q _n /t	Q
1	75-28-5	1.064	10	0.1064
2	75-56-9	0.051	10	0.0051
3	115-07-1	3.5	10	0.323
4	67-56-1	0.004	10	0.0004
5	67-64-1	0.072	10	0.0072
				0.4421

TBHP GB30000.18 1 2 3 GB30000.28
1 Q

10.3-1 1

10.3.2

10.3-2

10.3-2

	+			
				a
a				

10.3-1 10.3-2

10.4

10.4.1

2015

2015 80

10.4-1

10.4-1

CAS			
75-28-5			1
75-56-9			1
		/	2

		/	2
			1B
			2
		-	3
115-07-1			1
67-56-1		,	2
		-	3
		-	3
		-	3
		-	1
67-64-1		,	2
		/	2
		-	3

10.4.2

10.4-2

10.4-2

1			
2			
3			
4			
5			

10.4.3

/

10.4-3

10.4-3

--	--	--	--	--	--

			/		
			/		

10.5

HJ169-2018 A

10.5.1

10.5.2

10.5.3

10.6

10.6.1

1

GB/T50493-2019

2

DCS

3

E101

FV102

TBHP

TBA

TBHP

4

10.6.2

10.6.2.1

009193

5400

10.6-1

1		2m ³ =2m ³	2	24.37m ³ =24.37m ³	24.37
2		2018 8.43 150L/s 3h =3 3600 150 10 ⁻³ =1620m ³	1620	GB50160-2008 6.0L/ min m ² 13.72m ² 2=4 60 13.72 6.0 10 ⁻³ =19.76m ³	19.76
3		P=3 t=3h q=57.58L/s hm ² =0.95 0.08ha =57.58 0.95 0.08 3 3600 10 ⁻³ =47.26m ³	47.26	P=3 t=3h q=57.58L/s hm ² =0.95 0.009ha =57.58 0.95 0.009 3 3600 10 ⁻³ =5.3m ³	5.3
4		=0	0		0
5		= 1+ 2+ - 3	1669.26	= 1+ 2+ - 3	49.43

10.7-1 1718.69m³
5400m³

10.6.3

1

2

GB/T50934-2013

6.0m

1.0 10⁻⁷cm/s

3

5

10.6.4

10.6-3

10.6-3

1	300m	VOCs	15min/
2	200m		1h/

10.6-4

10.6-4

4	3M	6
2		
2m ³		2
1		

10.7

10.7-1

TBHP	PO/TBA

	/t	1.064	0.051	3.5	0.072	0.004
		500m		<u>0</u>	5km	
		200m				
			F1	F2	F3	
			S1	S2	S3	
			G1	G2	G3	
			D1	D2	D3	
	Q	Q 1	1_Q 10	10_Q 100		Q 100
	M	M1	M2	M3		M4
	P	P1	P2	P3		P4
		E1	E2		E3	
		E1	E2		E3	
		E1	E2		E3	
	+					
					/	
		SLAB	AFTOX			
			-1		<u>m</u>	
			-2		<u>m</u>	
			==		--h	
			<u>d</u>			
			--d			

11

11.1

TBHP

2018

TBHP

3

11.2

11.2.1

1

2

3

248

<

>

2012 179

2019 112

11.2-1

11.2-1

8	

9	
10	
11	
13	
14	<ul style="list-style-type: none"> 1 2 3 4
1	<p style="text-align: center;">7</p> <p style="text-align: right;">1</p> <p style="text-align: right;">2019</p>
2	
5	

--	--

HJ/T393-2007

1

2

2.5

1.5

1.8

3

4

a

b

c

d

5

10

6

15cm

7

a

b

c

d

e

8

9

a

b

c

d

e

f

10

2000 /100cm²

11

12

13

20

11.2.2

1

COD

2

2500 3000mg/L

11.2.3

1

2

3
11.2.4

200m

1

12 24cm

1 3cm

2

3

11.3

12.1

12.1-1

		-				
						-

12.2

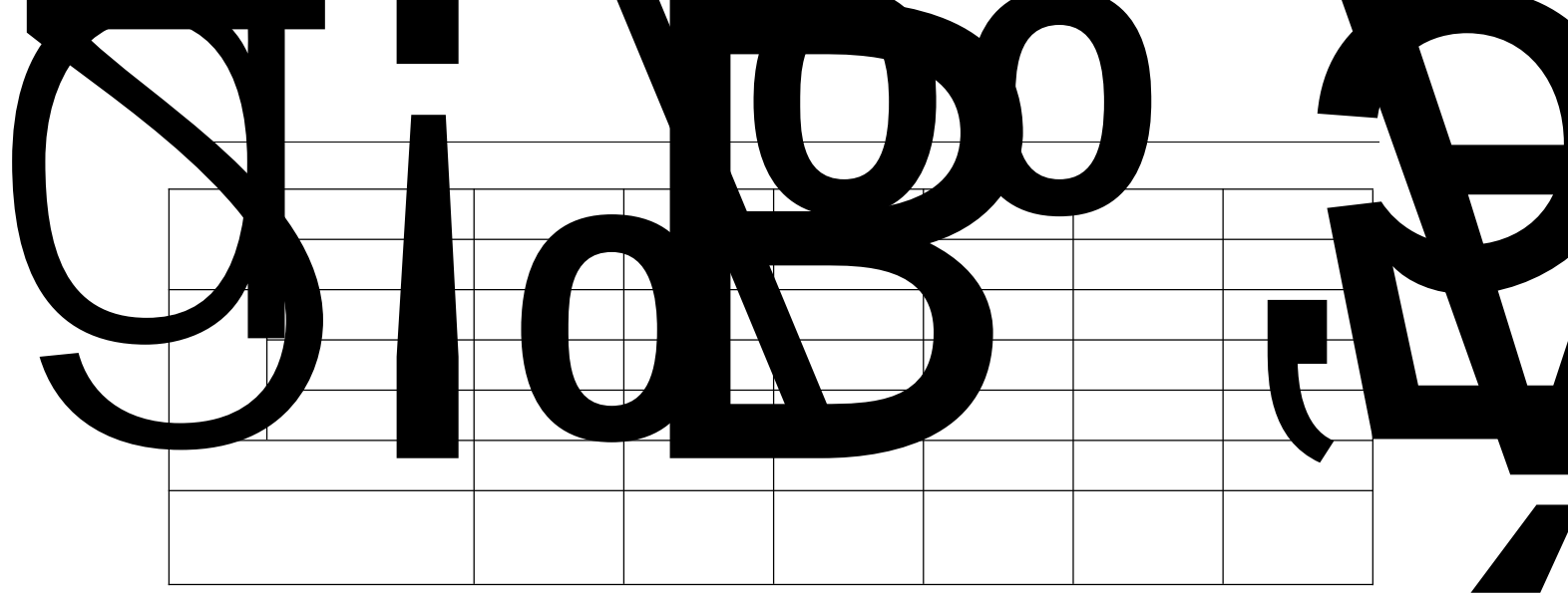

0.05mg/L

0.005mg/L

第 11 号 表

12.3-2

12.3-2

		/
1		0.4
2		1.2
3		0.8
4		2.4

12.3-2

2.4 / 表

286.2

--	--	--	--	--

HJ2025-2012

1

2

2013 2

3

GB18597-2001 A

GB13392-2005

4

12.5

GB12348-2008 3

1

2

3

4

GB12348-2008 3

2100

13.2-1

13.2-1

1			12
2			1.5
3			1
4			0.8
5			10
6			25.3

25.3

1.2%

13.2-2

13.2-2

1		
2		
3		
4		

14

14.1

2017	15	2020			2015	17%
	4.2					
		155.2	13.2	111.4	104.0	2015
11.7%	13.4%	27.0%	27.0%			153.7
2015		20.0%				

14.2

		119.25m ³		
		COD		
0.372t				
2019	132			
		2		2
		2		0.744t/a

14.3

HJ853-2017

14.3-1

14.3-1

		t/a	mg/m ³
	VOC _s	0.145	60
	VOC _s	0.227	2.0
		119.25	--
	COD	0.00024	50
		0.0000063	10

15.1

15.1.1

8

2

15.1.2

15.1.3

1

2

3

15562.1-1995

GB15562.2-1995

DB37/T2463-2014

DB37/T3535-2019

15.1-1



15.1-1

--

15.1-1

15.1-1

15.1-2

<p>废气监测点位名称</p> <p>单位名称: _____ 点位编码: _____</p> <p>经 度: _____ 纬 度: _____</p> <p>生产设备: _____ 投运年月: _____</p> <p>净化工艺: _____ 投运年月: _____</p> <p>监测断面尺寸: _____ 排气筒高度: _____</p> <p>污染物种类: _____</p> 	<p>废气监测点位名称</p> <p>单位名称: _____ 点位编码: _____</p> <p>经 度: _____ 纬 度: _____</p> <p>生产设备: _____ 投运年月: _____</p> <p>净化工艺: _____ 投运年月: _____</p> <p>监测断面尺寸: _____ 排气筒高度: _____</p> <p>污染物种类: _____</p> 
--	--

15.1-2

15.1-2

16

16.1

PO/TBA

M7320

2019

16.2

16.2.1

6.02km²

2019 144

16.2.3

2011 11 16

2011 143

16.2-1

16.2-1

1

/

2016-2020

22.92km²

10.86km²

2.9km

16.2-1

2

2019

6

GB/T3095 2012

19 g/m³

39 g/m³

92 g/m³

0.31

53 g/m³

0.51

1.7 mg/m³

204 g/m³

0.29

24

14

2019

15

11

11

7 ()

731

46.9 60.4

46.9

53.4 53.5 53.7 54.4

55.4

60.4

3

2654.64kg 136m³ 11.65kg 2.16 kW h
2160.48kg 10.66 m³ 4264kg 1.68 kg 5600m³ 2240kg
11330.77kg/a

4

PO/TBA

2019

16.3

16.3.1

2013 37

16.3-1

16.3-1

	2017 20 10	10

--	--	--

16.3.2

<

>

2017 121

16.3-2

16.3-2

1	VOCs		
2	LDAR		
3			
4			

16.3.3

2015 259

2015 259

16.3-3

16.3-3

2015 259

	2015 259		
1.			

2.

3.

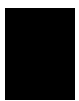

VOCs		
VOCs		
VOCs	5.2 kPa	
VOCs	2.8kPa	

16.3.7

2016 31

16.3-8

16.3-5

16.3.8

16.3-9

16.3-9

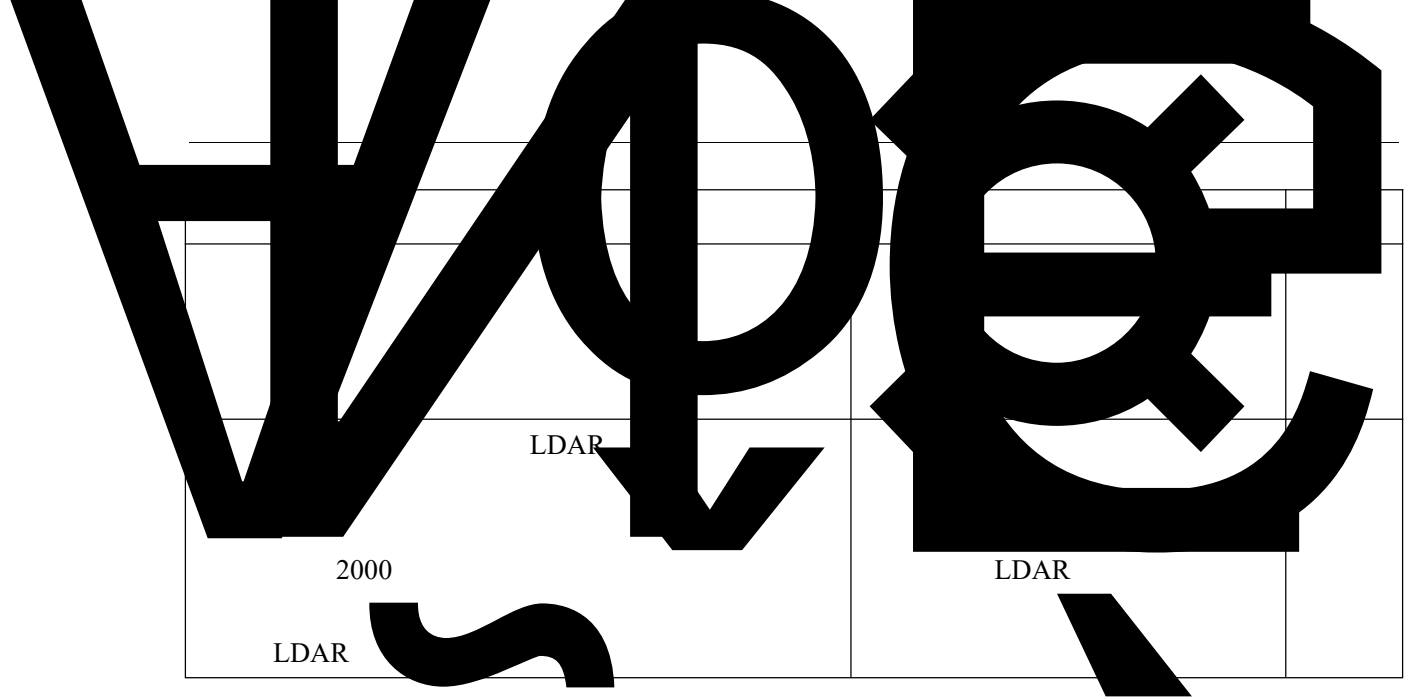

16.3.9

2016 150

2016 15

16.3.10 2016 1686

2016 1686

16.3-11

16.3-11

2016 1686

16.3.11 2017 331

6 <

>

2017 331

16.3-12

16.3-12

2017 331

1	VOCs	
2	LDAR	

2017 331

16.3.12

2018 22

16.3-13

16.3-13

2018 22

	2018 22		
	2020		

2018 22

2018 17

16.3.13

2018-2020

16.3-16

16.3-16

1.

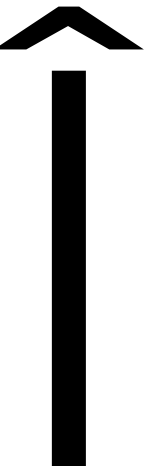



1500 m³

6.9 m³

40%

60%

Ca(OH)₂

70%

CaCl₂



17.1.2

17.1.2.1

2019

17.1.2.2

6.02km²

2019 144

17.1.3

1

TBA

TBHP

TBA

6m

VOCs

6

1

VOCs

6

DB37/2801.6-2018 2

2

3

TBHP/TBA

4

80

90dB A

17.1.4

COD

0.372t/a

2019 132

2

2

0.744t/a

17.1.5

17.1.5.1

2017

VOCs

VOCs

100%

17.1.5.2

4

DB37/3416.4-2018

2

17.1.5.3

3

1,2

GB/T14848-2017

7200d

COD

350m

17.1.5.4

GB12348-2008 3

17.1.5.5

- TBHP/TBA

17.1.6

17.2

17.2.1

17.2-1

17.2-1

	TBHP	VOCs	
		COD SS	
		--	

17.2.2

2

3

4
